



PIONEER NEW MEDIA TECHNOLOGIES, INC.

CLD-V2600
& CLD-V2400

See inside this Reference Guide for:

Level I — Manual Control of the CLD-V2600 & CLD-V2400

Level III — Computer Control of the CLD-V2600 & CLD-V2400

CLD-V2600

And CLD-V2400

LASERDISC/COMPACT DISC PLAYERS

LEVEL I & III

USER'S MANUAL

PROGRAMMER'S REFERENCE GUIDE



PIONEER NEW MEDIA TECHNOLOGIES, INC.

CLD-V2600

A

LASERDISC/COMPACT DISC PLAYERS

LEVEL I & III

USER'S MANUAL

PROGRAMMER'S REFERENCE GUIDE

CLD-V2600/2400 Level I & III Documentation
For Manual and Computer Control

Note to Users

This manual is based on the most up-to-date information for Level I and Level III program development and delivery on the CLD-V2600 & CLD-V2400 available at the time of publication. It is subject to change without notice. Although every reasonable effort has been made to include accurate information, the statements in this document are not warranties.

Pioneer New Media Technologies, Inc., makes no warranty or claims as to the accuracy, completeness or fitness for any particular purpose of the technical information provided herein. Throughout this manual **NOTES** appear reflecting details of the particular player functions which may be different on future players. The **NOTES** are included to aid understanding, but should not be depended upon in designing applications.

Please fill out the Registration Form on the next page and return it to the Pioneer address below to insure that you receive updated versions of the Level I & III Manual for the CLD-V2600/2400, and related support materials as they become available. Also, comments, observations, and/or corrections regarding this document would be appreciated.

Return Registration Form to and for more information contact:

Pioneer New Media Technologies, Inc.
Engineering and Product Development
Engineering Support
600 East Crescent Ave.
Upper Saddle River, NJ 07458
201/327-6400
FAX: 201/327-9379

East Coast Engineering Support:
201/327-6400

West Coast Engineering Support:
310/952-2111

Additional Error Messages

The RS-232 Error Messages described on page 4-3 of the **CLD-V2600 User's Manual**, also appear on the front panel illuminated display of CLD-V2600 players. There are two additional Error Messages that you may also see on the display. These two additional Error Messages are not returned in response to any RS-232 commands, but only appear on the front panel display. Here is a brief description of each:

1) E07 — Unrecoverable error

The player may read a portion of the disc, then spin it down. If the E07 error occurs when the player is reading material at the outside of the disc, check to make sure that the disc is not warped.

Lay the disc on a flat surface. If you can slide a dime under the center hole of the disc, it is warped. Check both sides. If the disc is warped, leave it on the flat surface, place several heavy books on it and leave it overnight. This will flatten out the disc, then you can try to play it again. Also, make sure the disc is free of scratches or greasy finger prints.

If the player still spins down the disc when searching or playing to the higher numbers of the disc, and you see the E07 error on the illuminated front panel, the player may need service. Call 1-800-872-4159 for your nearest Authorized Service Center.

2) E03 — Mis-clamp condition on spin-up

The player begins to spin up the disc, then immediately spins it down and you see the E03 error on the illuminated front panel of the player. This error can be caused by a disc that is out of specification. Try playing several different discs.

If the problem persists, and you see the E03 error on the front panel after trying to play several different discs, the player may need service. Call 1-800-872-4159 for your nearest Authorized Service Center.

**CLD-V2600/2400
Level I & III Documentation
For Manual and Computer Control**

Registration Form

Name: _____ Title: _____

Company: _____

Address: _____

City: _____ State: _____ Zip: _____

Phone: _____ Date: _____

Comments:

Please return this Registration Form and any comments you might have about this manual to:

Pioneer New Media Technologies, Inc.
Engineering and Product Development
Engineering Support
600 East Crescent Avenue
Upper Saddle River, NJ 07458-1827
201/327-6400
FAX: 201/327-9379

CLD-V2600/2400 LEVEL I & III DOCUMENTATION
For Manual and Computer Control

Note to Users
User Registration Form

CONTENTS

1. Introduction	1 - 1
1.1 Scope of Level I & III Manual	1 - 1
1.2 Features of the CLD-V2600 & CLD-V2400	1 - 1
1.3 Special Features of the CLD-V2600	1 - 2
1.4 Overview of Player Control Methods	1 - 2
1.5 Chapter Highlights	1 - 7
2. Operational Basics	2 - 1
2.1 Internal Operations	2 - 1
2.1.1 <i>Operating Modes</i>	2 - 1
2.1.2 <i>Active States</i>	2 - 1
2.2 Player Indicators - CLD-V2600 & CLD-2400	2 - 3
2.3 Interfaces	2 - 8
2.3.1 <i>Remote Sensor & The Barcode Terminal</i>	2 - 8
2.3.2 <i>RS-232C Interface Connector</i>	2 - 10
2.4 Function Switches	2 - 13
2.5 On-Screen Displays in Manual Mode	2 - 14
2.5.1 <i>Area 1: Chapt./Frame /Track /Time Displ.</i>	2 - 14
2.5.2 <i>Area 2: Audio, Speed, Repeat, CLV Display</i> ...	2 - 16
2.5.3 <i>Area 3: Argument Display</i>	2 - 19
2.5.4 <i>Area 3: Address Flag Display</i>	2 - 19

3. Manual Control — Level I	3 - 1
3.1 Front Panel Control	3 - 1
3.1.1 Stop-Open/Close (CLD-V2600 & CLD-V2400)....	3 - 1
3.1.2 Play (CLD-V2600 & CLD-V2400).....	3 - 2
3.1.3 Pause (CLD-V2600)	3 - 2
3.1.4 Skip Fwd/Rev (CLD-V2600 & CLD-V2400).....	3 - 2
3.1.5 Scan Fwd/Rev (CL D-V2400 Button; CL D-V2600 Dial)	3 - 3
3.1.6 Still Step Fwd/Rev (CLD-V2600).....	3 - 3
3.1.7 Display ON/OFF (CLD-V2600).....	3 - 3
3.2 Remote Control	3 - 4
3.2.1 Remote Control /CU-V113 & RU-V103.....	3 - 4
3.2.2 Description of Remote Control Functions	3 - 4
1) Reject	3 - 6
2) Pause	3 - 6
3) Play.....	3 - 6
4) Repeat Mode.....	3 - 7
5) Still/Step Forward/Reverse.....	3 - 9
6) Display.....	3 - 9
7) Scan Forward/Reverse	3 - 9
8) Audio.....	3 - 10
9) Speed Set Down/Up.....	3 - 11
10) Clear.....	3 - 12
11) Multi-Speed Forward/Reverse.....	3 - 12
12) Search.....	3 - 12
13) Chapter / Frame Track / Time	3 - 13
3.3 Barcode Control	3 - 15
3.3.1 LB Original Commands and LB2.....	3 - 15
3.3.2 Barcode-CD™ Commands	3 - 15
3.3.3 Creating Barcodes.....	3 - 15
3.3.4 LaserBarcode, LB2 and BC-CD Logos.....	3 - 16
3.3.5 Pioneer Barcoce Readers	3 - 17
3.3.6 Barcode Formats & Player Compatibility ...	3 - 17
3.3.7 Notes.....	3 - 17

4. External Computer Control — Level III	4 - 1
4.1 Command and Status	4 - 1
4.1.1 Request Status	4 - 2
4.2 Error Messages	4 - 3
4.3 Initial Settings	4 - 4
4.4 Level III Commands for LD & CD Control	4 - 5
4.5 Command Formats	4 - 7
4.6 Status Returns	4 - 9
4.7 Level III Command Descriptions	4 - 11
4.7.1 Player Control Commands	4 - 11
1) Door Open OP	4 - 11
2) Door Close CO	4 - 11
3) Reject RJ	4 - 12
4) Start SA	4 - 12
5) Play PL	4 - 13
6) Pause PA	4 - 14
7) Still ST	4 - 14
8) Step Forward SF	4 - 15
9) Step Reverse SR	4 - 15
10) Scan Forward NF	4 - 15
11) Scan Reverse NR	4 - 15
12) Multi-Speed Forward MF	4 - 16
13) Multi-Speed Reverse MR	4 - 16
14) Speed Set SP	4 - 17
15) Search SE	4 - 18
16) Stop Marker SM	4 - 20
17) Frame Set FR	4 - 21
18) Chapter Set CH	4 - 21
19) Time Set TM	4 - 22
20) Track Set TR	4 - 22
21) Index Set IX	4 - 23
22) Block Set BK	4 - 23
23) Clear CL	4 - 24
24) Lead-Out Symbol LO	4 - 24

4.7 Level III Command Descriptions (cont.)

4.7.2 <i>Player Control Switch Commands</i>	4 - 25
25) Audio Control AD	4 - 25
26) Video Control VD	4 - 25
27) Key Lock KL	4 - 27
4.7.3 <i>Display Control Commands</i>	4 - 28
28) Display Control DS	4 - 28
29) Clear Screen CS	4 - 29
30) Print Character PR	4 - 30
4.7.4 <i>Request Commands</i>	4 - 31
31) Frame Number Request ?F	4 - 31
32) Chapter Number Request ?C	4 - 31
33) Time Number Request ?T	4 - 32
34) Track Number Request ?R	4 - 32
35) Index Number Request ?I	4 - 33
36) Block Number Request ?B	4 - 33
37) P-Block Number Request ?A	4 - 33
38) TOC Information Request ?Q	4 - 34
39) Player Active Mode Request ?P	4 - 35
40) LD Disc Status Request ?D	4 - 36
41) CD Disc Status Request ?K	4 - 36
42) LVP Model Name Request ?X	4 - 37
4.7.5 <i>Communication Control Commands</i>	4 - 38
43) Communication Control CM	4 - 38
44) CCR Mode Request ?M	4 - 38
4.7.6 <i>Register Control Commands</i>	4 - 39
45) Register A Set (Display) RA	4 - 39
46) Register B Set (Squelch Control) RB	4 - 42
47) Register C Set (Miscellaneous) RC	4 - 43
48) Register A Request (Display) \$A	4 - 44
49) Register B Request (Squelch Control) \$B	4 - 44
50) Register C Request (Miscellaneous) \$C	4 - 45
4.7.7 <i>Input Device Control Commands</i>	4 - 46
51) Input Unit Request #I	4 - 46
52) Input Number Wait ?N	4 - 46

Appendices:

Appendix A:	Level III Commands	A - 1
Appendix B:	Remote Control Units	
	• CU-V113 and RU-V103.....	B - 1
Appendix C:	Interface Cable Specifications.....	C - 1
Appendix D:	LaserBarcode™ & LB2™ Commands, Logo ...	D - 1
Appendix E:	Barcode CD™ Commands & Logo.....	E - 1
Appendix F:	Barcode Formats and Player Compatibility..	F - 1
Appendix G:	Pioneer Barcode Readers	
	• UC-V109BC & UC-V108BC.....	G - 1
Appendix H:	Internal Player Controls.....	H - 1
Appendix I:	Internal Player Registers	I - 1
Appendix J:	Additional Notes	J - 1

Accompanying Figures, by Chapter

Figure No.	Title	Page No.
Chapter One		
Figure 1 - A	Controlling CLD-V2600/2400 LD/CD Players	1 - 4
Figure 1 - B	Level I — Manual Control	1 - 5
Figure 1 - C	Level III — External Computer Control	1 - 6
Chapter Two		
Figure 2 - A	Operating Modes	2 - 2
Figure 2 - B	Transitions Between Active States	2 - 3
Figure 2 - C	CLD-V2600 Front Illuminated DISPLAY WINDOW .	2 - 4
Figure 2 - D	CLD-V2600 FrontPanel View.....	2 - 5
Figure 2 - E	CLD-V2600 Rear Panel View	2 - 6
Figure 2 - F	CLD-V2400 Front Panel View.....	2 - 7
Figure 2 - G	CLD-V2400 Rear Panel View	2 - 7
Figure 2 - H	Waveform of Infrared Remote Control Signal	2 - 8
Figure 2 - I	Barcode Terminal Plugs.....	2 - 9
Figure 2 - J	Waveform of Wired Remote Control Signal.....	2 - 9
Figure 2 - K	Remote Sensor & Barcode Terminal.....	2 - 10
Figure 2 - L	15-Pin D-Sub Connectors	2 - 10
Figure 2 - M	Serial Interface Pin Outs.....	2 - 11
Figure 2 - N	Data Type.....	2 - 11
Figure 2 - O	Computer to Player Connection	2 - 12
Figure 2 - P	Function Switches	2 - 13
Figure 2 - Q	On-Screen Displays in Manual Mode	2 - 14
Figure 2 - R-Y	On-Screen Displays	2 - 15 to 2 - 18

Accompanying Figures, by Chapter

Figure No.	Title	Page No.
Chapter Three		
Figure 3 - A	CLD-V2600/CLD-V2400 Front Panel Buttons.....	3 - 1
Figure 3 - B	List of Remote Control Functions	3 - 4
Figure 3 - C	Diagram of CU-V113 / RU-V103 Remote Control	3 - 5
Figure 3 - D	Repeat Mode	3 - 7
Figure 3 - E	Audio Switches, LD Analog and Digital Sound	3 - 10
Figure 3 - F	Audio Switches, LD Analog Sound	3 - 10
Figure 3 - G	Audio Switches, CD-Digital Sound.....	3 - 11
Figure 3 - H	Speed Set Down / Up.....	3 - 11
Figure 3 - I	LaserBarcode Logo	3 - 16
Figure 3 - J	LaserBarcode 2 Logo	3 - 16
Figure 3 - K	Barcode CD Logo.....	3 - 16
Chapter Four		
Figure 4 - A	Commands and Completion Status	4 - 1
Figure 4 - B	Status Reporting	4 - 3
Figure 4 - C	Error Messages	4 - 3
Figure 4 - D	Initial Settings.....	4 - 4
Figure 4 - E	List of Level III Commands	4 - 5, 6
Figure 4 - F	Fr., Chapt., Tm, Tr., Index, Block Addresses	4 - 7
Figure 4 - G	Timing Diagram	4 - 10
Figure 4 - H	Level III Speed Set	4 - 17
Figure 4 - I	CD Address Flags.....	4 - 19
Figure 4 - J	Stop Marker Diagram	4 - 20
Figure 4 - K	Audio Control Register	4 - 26
Figure 4 - L	Audio Switch Diagram.....	4 - 26
Figure 4 - M	Video Control Diagram	4 - 27
Figure 4 - N	Display Control Diagram	4 - 28
Figure 4 - O	Character Code Table	4 - 30
Figure 4 - P	Player Active Mode Request Codes.....	4 - 35
Figure 4 - Q	Setting Level III Register A Contents	4 - 39
Figure 4 - R	Register A: Display Control Diagram.....	4 - 39
Figure 4 - S	Register A: User's Display Area CLD-V2600	4 - 40
Figure 4 - T	Register A: User's Display Area CLD-V2400	4 - 40
Figure 4 - U	Setting Level III Register B Contents	4 - 42
Figure 4 - V	Setting Level III Register C Contents	4 - 43

1. Introduction

1.1 Scope of Level I & III Manual

1.2 Features of the CLD-V2600 & CLD-V2400

1.3 Special Features of the CLD-V2600

1.4 Overview of Player Control Methods

1.5 Chapter Highlights

CHAPTER

1

CLD-V2600

& CLD-V2400

LEVEL I & III

USER'S MANUAL

Programmer's Reference Guide

1 Introduction

Please refer first to the **Operating Instructions**, packaged with the CLD-V2600 or the CLD-V2400, for essential information about player operation and safety.

1.1 Scope Of Level I & III Manual

This manual is a reference guide to assist programmers and developers in using the Pioneer Industrial Combination LaserDisc/Compact Disc Player, Model CLD-V2600 & Model CLD-V2400. It contains information for Level I direct player control using the front panel buttons, a remote control unit (CU-V113 or RU-V103), or a Pioneer barcode reader (UC-V108BC or UC-V109BC). It also contains technical information to assist programmers in the design and development of Level III program applications to run under computer control.

All Pioneer Industrial Laser Videodisc Players, Models CLD-V2600, CLD-V2400, LD-V4400, LD-V8000, LD-V2200, and the LD-V2000, can be used as stand-alone systems. When connected to a television or video monitor, they become self-contained interactive audio-video retrieval and display systems for Level I use. They may also be connected to and controlled by an external computer for Level III applications, often working in conjunction with computer databases.

The CLD-V2600, CLD-V2400, LD-V4400, LD-V8000 can be connected to a stereo amplifier and speaker system for playback of high quality digital sound. This feature is especially useful when playing compact audio discs or LaserDiscs with digital audio.

Controlling the CLD-V2600 or the CLD-V2400 as part of a Level I or Level III delivery system is the main focus of this manual.

1.2 Features of the CLD-V2400 and the CLD-V2600

The CLD-V2400 and the CLD-V2600 players include the following features:

- Playback of LaserDiscs (LDs), compact audio discs (CDs) and compact disc video (CDVs). The CLD-V2400 & 2600 *do not* playback CD-ROM discs.
- Playback of digital audio or analog audio playback from LaserDiscs.
- RS-232C interface, compatible with the Pioneer LD-V8000, LD-V2200, LD-V4400 and the LD-V4200 (discontinued), LC-V330 Autochanger, the LD-V4100 (PAL player), and the CLD-V2300D & LD-V4300 (Dual Standard NTSC/PAL players).
- Built-in LaserBarcode™, LaserBarcode 2™, and Barcode-CD™ capability, using the Pioneer barcode reader UC-V108 BC or UC-V109BC.
- Wireless/wired remote control with the CU-V113 or the RU-V103.
- Fully automatic disc loading system.

LaserBarcode™ and LaserBarcode 2™ are Registered TradeMarks of Pioneer Electronics Corp. Barcode-CD™ is a Registered Trademark of SONY, Inc.

1.3 Special Features of the CLD-V2600

The CLD-V2600 has all the features of the CLD-V2400 and more. Additional features of the CLD-V2600 include:

- The CLD-V2600 is well-suited to extended operation in kiosks, etc.
- It has a 12 line x 20 character user display (2 more lines than CLD-V2400).
- It is fully plug compatible with CLD-V2400 with the same RS-232C mnemonic command set.
- The headphone jack with volume control, the SCAN control shuttle dial, and the front panel illuminated display all help to make this player ideal for use in individual work stations or as part of multimedia “creation stations”.
- Three video output options: S-Video, Composite Video or RF Modulated video for ease of connection to different video or TV monitors.

1.4 Overview of Player Control Methods

The CLD-V2600 & the CLD-V2400 player can be used for **Level I** or **Level III** control of LaserDiscs (LDs), compact audio discs (CDs) or compact video discs (CDVs). **NOTE:** The use of the term CD in this manual refers primarily to CD audio discs and includes, by inference, CDVs. The three player control methods are:

- **Level I** — Manual Control using a remote control unit (CU-V113 & RU-V103), using a Pioneer barcode reader, or using the player’s front panel buttons. (LD/CD)
- **Level II** — Internal Program Control by loading Level II programs into a Level II compatible player’s memory. Usually the programs are specially encoded onto a Level II videodisc. *The CLD-V2600 and the CLD-V2400 players do not have built in Level II capability.*
- **Level III** — External Computer Control by sending commands from an external computer to the player via the RS-232C serial interface. (LD/CD)

Levels I, II and III describe the delivery platforms for interactive videodisc applications:

- A **Level I** system consists of a videodisc player and a monitor. The player is controlled by using a remote control unit or a Pioneer barcode reader or the front panel buttons on the player. Level I is used for playing discs continuously, for simple searches, for searching to and stepping through a specific series of still frames (LD) or tracks (CD), or for playing discrete motion video segments (LD) or discrete audio segments (CD).

- **Level II** systems are comprised of various hardware configurations. A Level II system usually consist of only a videodisc player with a programmable memory, such as the LD-V8000, a monitor and a remote control unit. However, Level II systems can include additional hardware such as a touch screen, printer, etc.

In Level II, these systems are controlled by loading a Level II program into the memory of the player from a program specially encoded Level II videodisc, or by sending ASCII-Hex commands to the player's memory from the remote control unit or via the RS-232C interface from an external computer.

The CLD-V2600 & CLD-V2400 Videodisc players do not support Level II applications. For more information on Level II, refer to Pioneer's **LD-V8000 Level II User's Manual/ Programmer's Reference Guide, TP114 v.2.1**, available through Pioneer New Media Technologies, Inc., Engineering Support:

East Coast: 201/327-6400,
West Coast: 310/952-2111.

- A **Level III** system generally consists of an LD player, or a combination LD/CD player (CLD-V2600 or the CLD-V2400), a monitor and a computer. The system is controlled by the computer. This provides an interactive system allowing access to computer data as well as access to audio and/or video material on the disc (LDs or CDs).

See **Figures 1-A, 1-B, 1-C**, on pages 1-4 through 1-6 for diagrams of Level I and Level III hardware configurations using a CLD-V2600 or CLD-V2400 industrial videodisc player.

Controlling the CLD-V2400 or CLD-V2600 LD/CD Player

- **Level I — Manual Control**
Player is controlled using a Remote Control or Barcode Reader or Front Panel Buttons
- **Level III — Computer Control**
Commands to control the player are sent via RS-232C from a computer or external controller

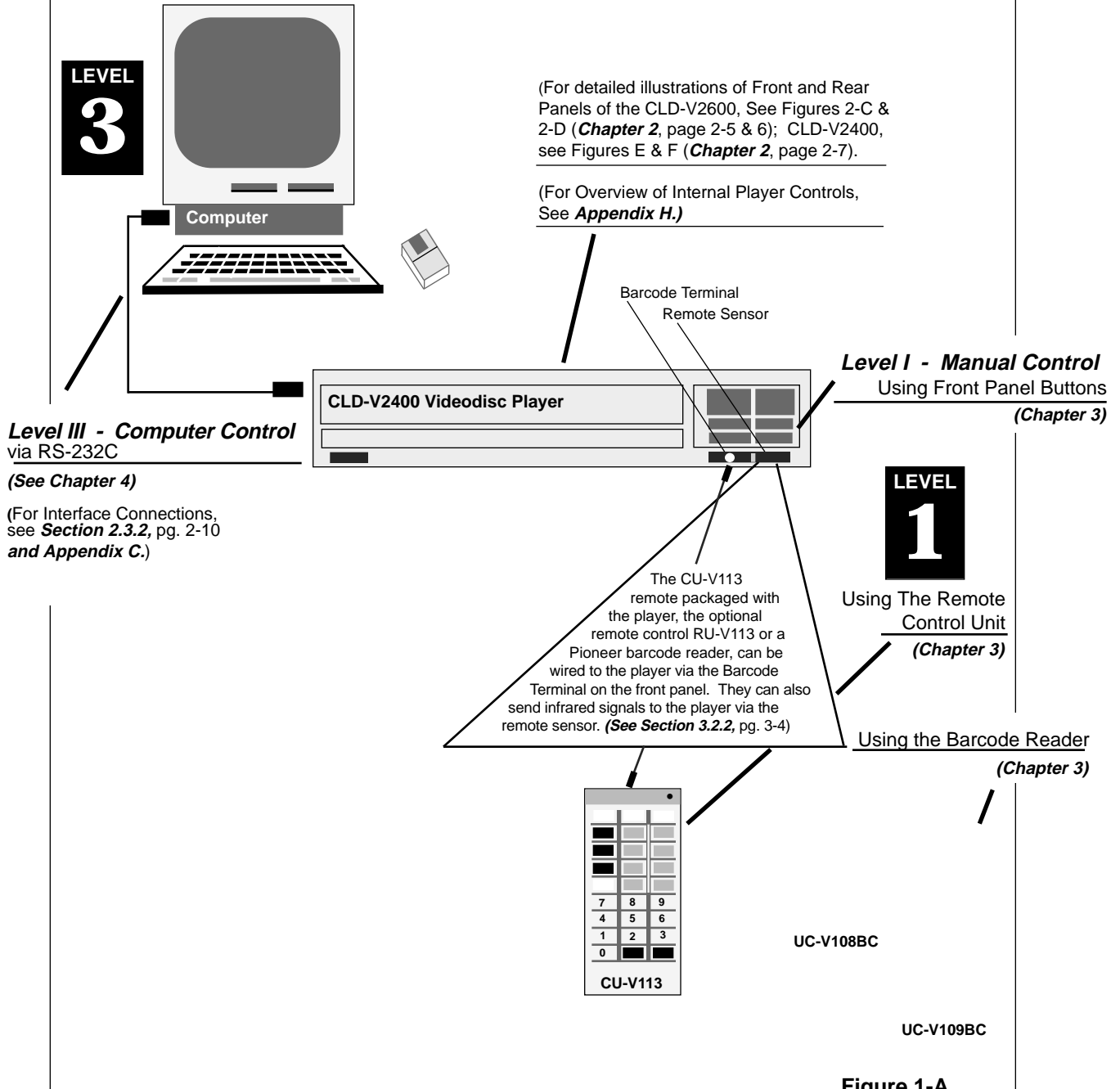
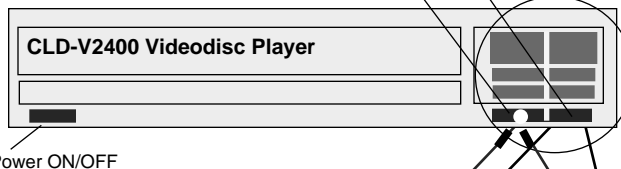

Figure 1-A

Level I — Manual Control

In Level I, the player is controlled by using Remote Control Buttons on the CU-V113 or the RU-V103, by scanning original LaserBarcodes, extended LaserBarcode 2 barcodes, or Barcode CD barcodes, or by using the Front Panel Buttons. Manual Control (Level I) allows simple control of the player using such commands as Play, Stop, Still, Step Forward, etc.

LEVEL
1



See **Front Panel Buttons** described below

Remote Control Units

The CU-V113 remote control unit packaged with the player, or the optional remote control RU-V103, can be used to control the player. The remote control sends an infrared signal to the player's remote sensor, or it sends signals via a wired connection to the Barcode Terminal on the front of the player.



Barcode Reader

A Pioneer Barcode Reader, the UC-V108BC or the UC-V109BC, can be used to send an infrared signal to the player via the remote sensor. It can also send a signal via a wired connection through the Barcode Terminal on the front of the player.

UC-V108BC UC-V109BC

OPEN /CLOSE

Opens and closes disc tray.

PLAY

Spins-up & plays videodisc.

SKIP

Forward & Reverse

Skips forward or backward by chapters (LD) or tracks (CD).

SCAN

Forward & Reverse

Moves rapidly forward or backward through material on a disc.

POWER ON/OFF

Powers the player ON / OFF. This button is on the lower left side of the front panel.

PAUSE

Pauses playback, presents a squelch screen.

STILL FORWARD & REVERSE

Holds a still image on CAV, and steps forward or back one frame at a time.

DISPLAY

Displays the Chapter, Frame or Time number on the screen, indicating location on the disc.

CLD-V2400 Front Panel Buttons

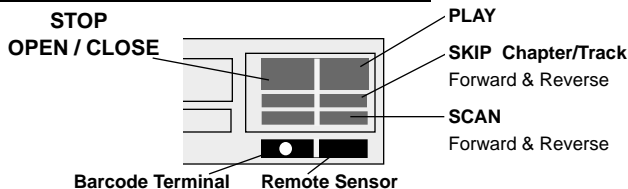

CLD-V2600 Front Panel Buttons, Details

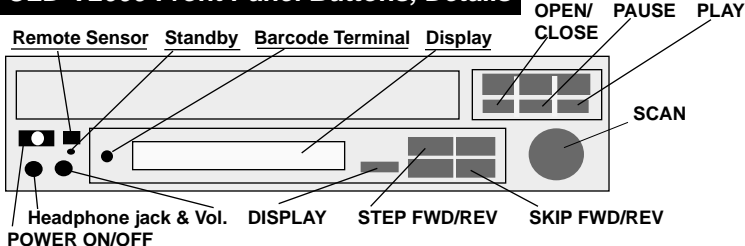

For information about using the Front Panel Buttons, the Remote Control Unit (CU-V113 or RU-V103) or a Pioneer Barcode Reader for Manual Control (Level I Control) of the CLD-V2600 or the CLD-V2400, see **Chapter 3**.

Figure 1-B

Level III — External Computer Control

Level III programs are used to control the player from an external computer attached to the player's RS-232C port. The player's Level III mnemonic command set is used to develop interactive programs for the CLD-V2600 or the CLD-V2400. (See **Section 4.4** on pages 4-5 and 4-6 or **Appendix A** for the list of mnemonic commands available.) Level III mnemonic commands are also used to control the LD-V8000, the LD-V4400, and the LD-V2200 (NTSC players), LD-V4200 (discontinued NTSC player), the CLD-V2300D and the LD-V4300D (NTSC/PAL players), and the LD-V4100 (PAL player). See **Technical Bulletin #143**, **Comparative Mnemonic Command Chart**. Level III is often used when a program designer wants users to access a large database from a computer, along with video and audio material on a disc. Level III requires that a computer be connected to every player. A file server may be used to network the computers at the various workstations.

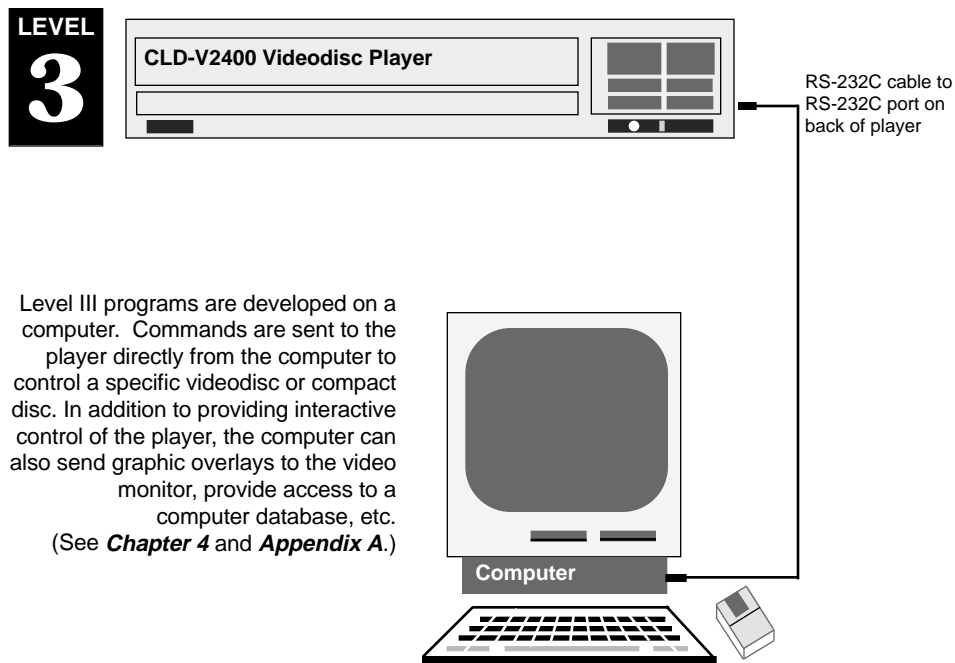

For detailed information about Computer Control of the CLD-V2600 and the CLD-V2400, see **Chapter 4** and **Appendix A** of this manual.

Figure 1-C

1.4 Chapter Highlights

This manual provides:

- An overview of player operating processes.
- How to customize player functions by using Function Switches and On-Screen Status Displays.
- Specific information about Manual and Computer control.

It is divided into chapters providing the following information:

Chapter One — Introduction

This chapter describes the scope and overview of the ***Pioneer CLD-V2600 & CLD-V2400 Level I and III User's Manual*** and explains how information is organized. It also defines Level I, II, III as they relate to specific hardware configurations, and illustrates Level I and III configurations.

Chapter Two — Operational Basics

This chapter gives an overview of the player's internal operating processes, describing *Operating Modes* and *Active States*, and the front panel indicators. It also describes player interfaces: The infrared sensor, used to receive infrared barcode and remote control signals; the barcode terminal, used to receive wired barcode and remote control signals; and the RS-232C serial interface.

There are also illustrations of the front and rear panels of both players showing the front panel LEDs and buttons; rear function switches, audio output jacks, video output jacks and the RS-232C port.

There is also a section describing the player's Function Switches and the On-Screen Status Displays.

Chapter Three — Manual Control — Level I

This chapter describes the player's front panel buttons, the remote control buttons on the CU-V113 & RU-V103, and features of the Pioneer barcode readers. All of these can be used for Level I control of the CLD-V2600 or the CLD-V2400 while playing LDs or CDs.

Chapter Four — External Computer Control — Level III

This chapter explains how commands are sent to the CLD-V2600 and the CLD-V2400 from an external computer to control playback of LDs or CDs. It also describes error messages that may be returned, the default settings, a basic list of Level III commands and descriptions of each command.

Commands are described by categories: Player Control Commands, Player Control Switch Commands, Display Control Commands, Request Commands, Communication Control Commands, Register Control Commands, and Input Device Commands.

For additional information see the attached Appendices:

- Appendix A** Level III commands on the CLD-V2600 & CLD-V2400
- Appendix B** Remote Control Units — *CU-V113* & *RU-V103*
- Appendix C** CLD-V2600 & CLD-V2400 Interface Cable Specifications
- Appendix D** LaserBarcode™, LB2 Commands & Logo
- Appendix E** Barcode CD™ Standard Commands & Barcode CD Logo
- Appendix F** Barcode Formats and Player Compatibility
- Appendix G** Pioneer Barcode Readers — *UC-V108BC* & *UC-V109BC*
- Appendix H** CLD-V2600 & CLD-V2400 Internal Player Controls
- Appendix I** CLD-V2600 & CLD-V2400 Internal Player Registers
- Appendix J** Additional Notes

Further questions should be referred to:

Pioneer New Media Technologies, Inc.
Engineering & Product Development
Engineering Support
600 East Crescent Avenue
Upper Saddle River, New Jersey 07458-1827 USA
201/327-6400
FAX: 201/327-9379

East Coast Engineering Support:
201/327-6400

West Coast Engineering Support:
310/952-2111

2. Operational Basics

2.1 Internal Operations

2.2 Player Indicators

2.3 Interfaces

2.4 Function Switches

2.5 On-Screen Displays in Manual Mode

CHAPTER

2

CLD-V2600

& CLD-V2400

LEVEL I & III

USER'S MANUAL

Programmer's Reference Guide

2 Operational Basics

This chapter provides an overview of the player's internal operations — Operating Modes and the player's Active States; diagrams of the player's Front and Rear Panels; a description of the player's Front Panel Indicators, Player Interfaces, and Function Switches. Before developing or presenting programs on the CLD-V2600 or CLD-V2400 the user should read this chapter and become familiar with the introductory concepts, illustrations and operational basics. (See **Appendix H, CLD-V2600 & CLD-V2400 Internal Player Controls**, for more details.)

2.1 Internal Operations

The player's internal operating processes are classified into two groups: *Operating Modes* indicating player operation status, and *Active States* indicating player processing status.

2.1.1 Operating Modes

The CLD-V2600 and the CLD-V2400 have the following two *Operating Modes*: *Normal Control Mode* and *Test Mode*. (See **Figure 2-A** on next page.)

These modes are defined as follows:

1) Normal Control Mode

When the player's power is turned on, the player enters *Normal Control Mode*. In this mode, the player can be controlled by pressing buttons on the front panel, by pressing buttons on the remote control unit, by sending commands via the Pioneer barcode reader, or by sending commands from a computer via the RS-232C connector.

2) Test Mode

The *Test Mode* is set in Register C under computer control. (See page 4-43) It is used for player maintenance and management. This mode is used primarily by Authorized Service Company (ASC) personnel to determine key part numbers of the player and to service the player. Generally, the player is not controlled in this mode. Turn ON (1) bit 7 of Register C via computer control to make the CLD-V2600 or the CLD-V2400 enter this mode. Turn OFF (0) bit 7 of Register C to change the operating mode from *Test Mode* to *Normal Control Mode*.

2.1.2 Active States

CLD-V2600 & CLD-V2400 processing is performed within several distinct *Active States*. When a command is executed, the *Active State* changes inside the player. If you consider player processing as a series of events within the *Active States* listed below, it is easier to understand the effects of various commands. The player's five main *Active States* are:

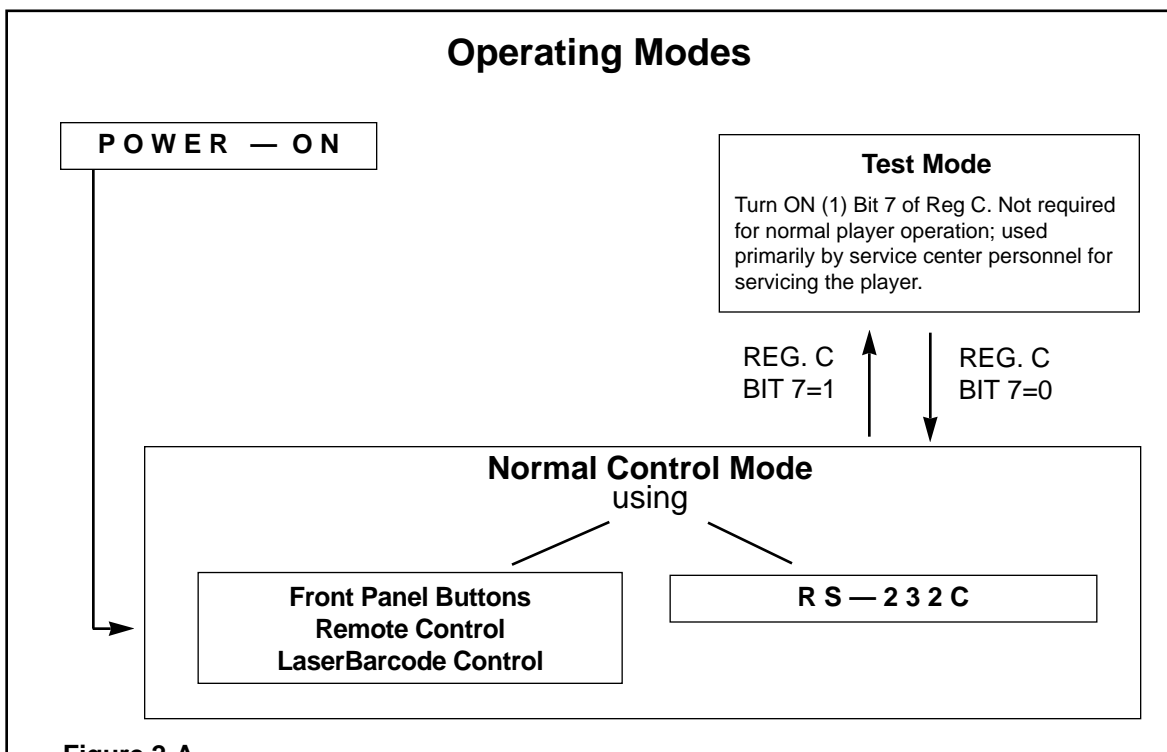
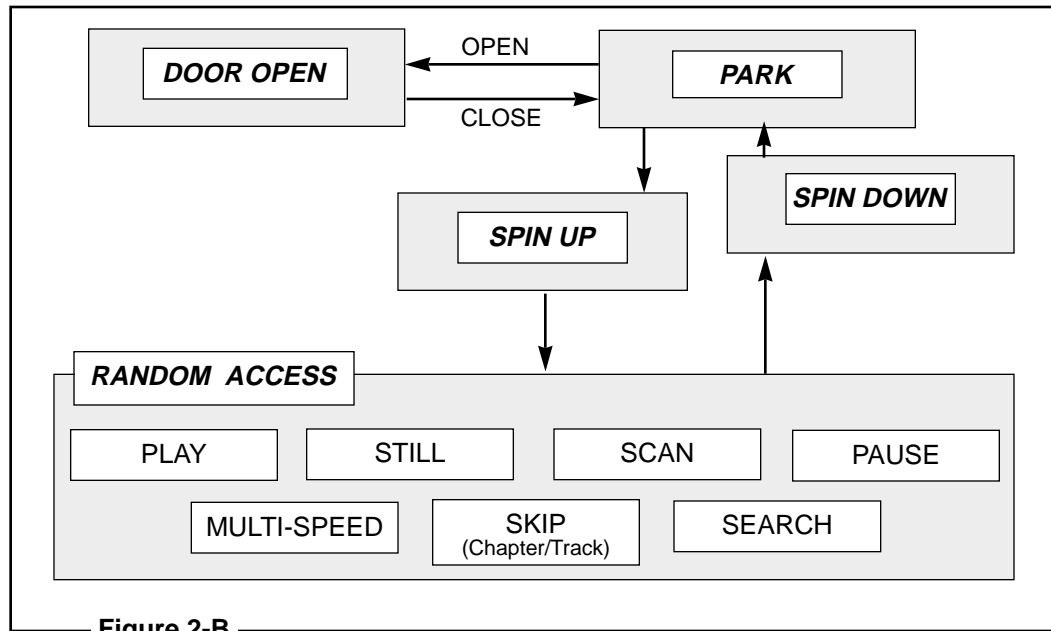

Figure 2-A

- *Door Open*
- *Park*
- *Spin Up*
- *Random Access*
- *Spin Down*

The player is in *Door Open* before the disc is loaded into the disc tray. After the door is closed, the player enters *Park*. When a START or PLAY command is input while the player is in *Park*, the disc starts rotating and the player enters *Spin Up*. When the player is ready to play images, it enters *Random Access*. *Random Access* is further divided into *Play*, *Still*, *Scan*, *Pause*, *Multi-Speed*, *Skip (Chapter and Track)* and *Search*.

When a REJECT command is received, the player enters *Spin Down Mode*. Image playback stops immediately, and disc rotation is gradually stopped, then the player enters *Park*. **Figure 2-B**, on the next page, describes how the active states change within the player.

Transitions Between Active States

2.2 Player Indicators for the CLD-V2400 & CLD-V2600

The CLD-V2400 has four indicator lights on the front panel. These four indicators are explained below. (See diagram of CLD-V2400's Front Panel, **Figure 2-F**, on page 2-7.)

Digital Sound (green) — This indicator lights up after power is turned on, except when a disc with no digital audio is in the disc tray.

Disc Set (green) — The Disc Set indicator lights up when a disc is loaded in the player.

Play/Standby (green)— This indicator flashes when the disc begins to spin up, when disc rotation stops, during a search and while in the lead-out area. It also lights up during playback.

Key Lock Indicator (red) — The Key Lock indicator lights up if a computer command has been sent to the player to lock out the front panel buttons, the barcode reader and remote control buttons, preventing them from being used during execution of a Level III program.

The CLD-V2600 has an illuminated front panel display and a Standby light that indicates the player is plugged in, but not powered on. It also has a Key Lock light, indicating when the front panel buttons or remote control or LaserBarcode Control have been locked out under Level III, RS-232C control. Please see **Figure 2-C** on the next page for details of the illuminated display window on the front panel. Also see **Figure 2-D** on page 2-5 for other details on the Front Panel.

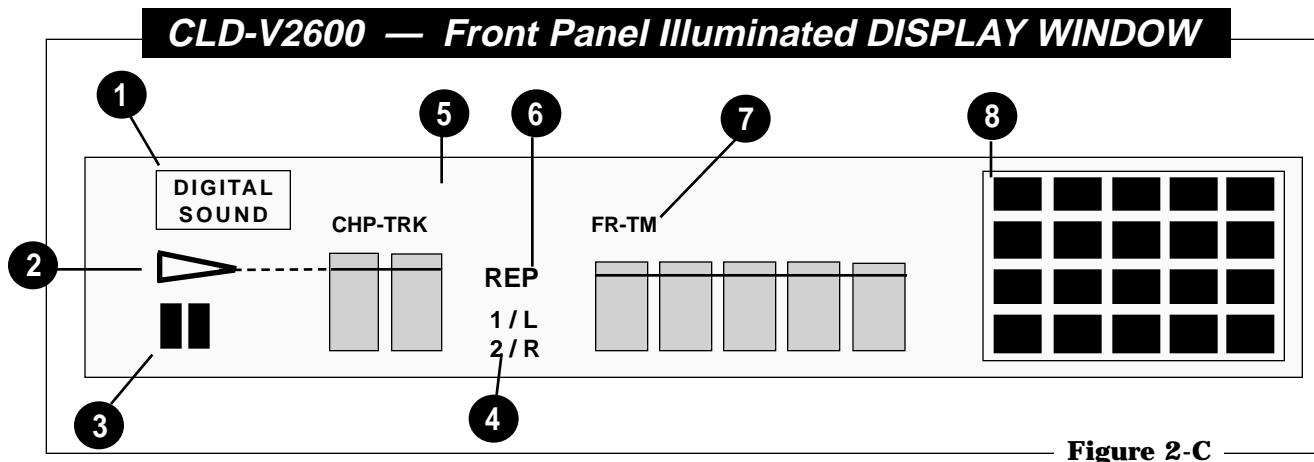

Figure 2-C

1. **DIGITAL SOUND INDICATOR:** This indicator lights when the disc being played has digital audio and when the digital audio signal is output from a LaserDisc. When analog audio is selected from a disc with digital audio, this indicator does not light.
2. **PLAY:** This indicator lights during playback and blinks during search. The Chapter-Track or Frame-Time numbers to the right of this indicator, show the current playback location on the disc.
3. **PAUSE INDICATOR:** This indicator lights when the player is in *Pause Mode*.
4. **1/L, 2/R INDICATOR:** Indicates the audio output channel.
5. **CHP/TRK INDICATOR:** Indicates the Chapter number on an LD, or Track number on a CD Audio disc.
6. **REP INDICATOR:** This lights when Repeat Chapter or Repeat Side has been selected.
7. **FRM-TM INDICATOR:** Indicates the Frame number on a CAV LaserDisc or Time number on a CLV LaserDisc or the Time number on a CD Audio disc. (You will notice that short words appear in this location to indicate player status. NO DISC: “No disc in tray”; OPEN: “Opening disc tray”; CLOSE: “Closing disc tray”; DISC: “Spinning up disc”; LD: “LaserDisc is in the tray”; CD: “CD Audio disc is in tray”.)
8. **VISUAL CALENDAR:** If a Table of Contents (TOC) is present on an LD, all of the Chapter numbers recorded on the disc light up as the disc starts and if the disc contains more than 19 chapters, the > indicator lights in the last square. After a chapter has finished playing, the corresponding number goes out. When an LD without a TOC is played, only the current chapter being played lights up. All CDs have TOCs, so all of the track numbers recorded on the disc light up as the disc starts. If the CD has more than 19 tracks, the > indicator lights in the last square. After a track has finished playing, the corresponding number goes out.

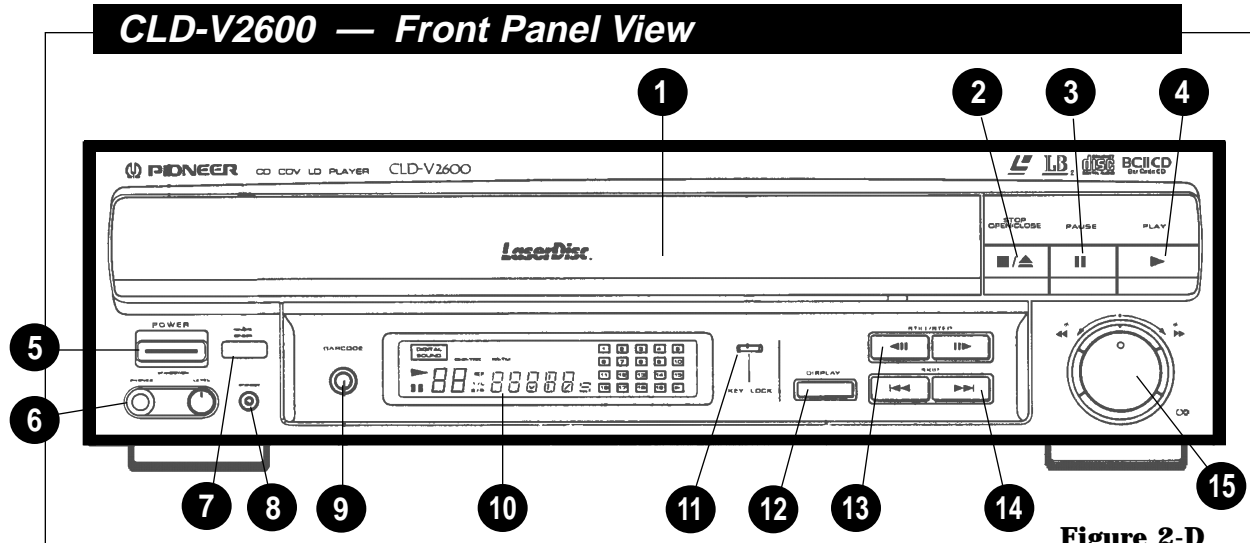

Figure 2-D

- 1 **DISC TRAY:** Press the STOP OPEN /CLOSE button to open the door and eject the tray.
- 2 **STOP OPEN CLOSE BUTTON:** Press this button to open and close the disc tray. Place a disc on the disc tray then press this button to retract the disc tray into the player. Press this button while a disc is playing to stop playback. Press it again to eject the tray.
- 3 **PAUSE BUTTON:** Press this button to stop playback temporarily. To resume playback, press the PLAY button.
- 4 **PLAY BUTTON:** Press this button to start playback or to resume ordinary playback from a still image or from pause mode.
- 5 **POWER BUTTON:** Press this button to turn the power ON and OFF.
- 6 **HEADPHONE JACK & VOLUME CONTROL:** Plug a headphone set into this jack, use the "LEVEL" knob to control the volume.
- 7 **REMOTE SENSOR:** Infrared commands from the remote control unit or from a wireless LaserBarcode reader are received here.
- 8 **STANDBY INDICATOR:** This indicator lights up when the power is off.
- 9 **BARCODE JACK:** Connect a Pioneer LaserBarcode Reader (UC-V108BC or UC-V109BC) via this jack.
- 10 **DISPLAY WINDOW INDICATORS:** See page 2-4 for details.
- 11 **KEY LOCK INDICATOR:** This indicator lights up when the Key Lock command is sent from a computer or external control unit. When it is lit, front panel buttons other than the power switch are disabled. Also, signals from a remote control unit or optional LaserBarcode reader are not accepted.
- 12 **DISPLAY BUTTON:** Pressing this button displays the chapter (CAV or CLV), track (CD Audio), frame (CAV) or time number (CLV or CD Audio) on the TV screen or video monitor. Pressing it again removes the numbers from display. **NOTE:** With CDs, the track, index and elapsed time will be displayed when this button is pressed while the absolute time is displayed.
- 13 **STILL / STEP BUTTONS:** Press either of these buttons to produce a still video image. Pressing the STEP FWD button again moves the image forward one frame at a time. STEP REV presents each preceding frame. (CAV discs only. These buttons do not function with CLV discs.)
- 14 **SKIP BUTTONS:** Press the SKIP FWD button to advance to the next chapter or track and start playback. Press the SKIP REV button once to return the player to the beginning of the current chapter or track. Pressing this button several times before pictures or audio is played, will search back a corresponding number of chapters or tracks.
- 15 **SCAN CONTROL:** Rotate the SCAN CONTROL dial to advance or reverse playback rapidly. On CLV discs, slightly rotate the dial for a clear picture scan. Rotate the dial further for a normal CLV Scan. On CAV discs, rotate the dial slightly to play back the disc at 9x normal speed. Rotate fully to play back at 32x normal speed. Both CAV scan speeds present clear picture scan. (See page 3-3.)

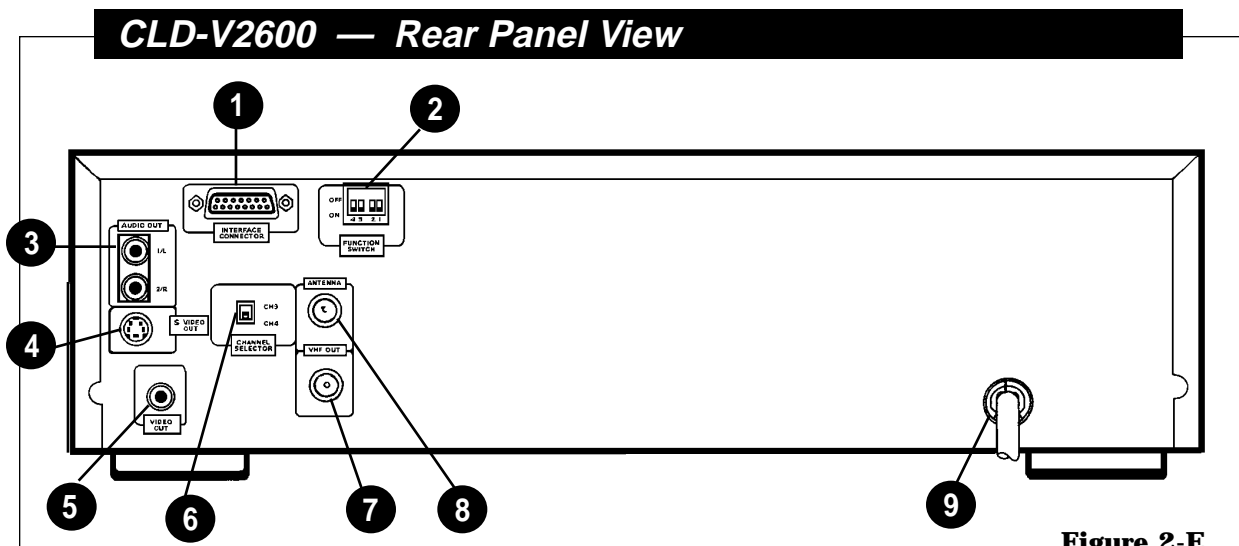

Figure 2-E

- 1. INTERFACE CONNECTOR RS-232C (D-SUB 15 pin):** This provides a serial interface connection to a computer or controller. (See Appendix C of this Manual for cable descriptions, or Pioneer Product Information Bulletin #6.)
- 2. FUNCTION SWITCHES:** Switch 1 sets Load Start /Power On Start ON or OFF. Switch 2 sets Baud Rate to 1200 or 4800. Switch 3 sets the Squelch on the monitor to Black or Blue. Switch 4 is not used. The factory default sets all switches OFF (in the UP position): Load Start /Power On Start is OFF; Baud Rate is 4800; Squelch is set to Blue. If the function switch settings are changed, initialize the player by turning the power OFF and ON again.
- 3. AUDIO OUT TERMINALS (RCA Jacks):** These terminals output the audio signals from LaserDiscs or Compact Discs. Connect them to the Audio IN jacks on the back of a video monitor. Or connect them to the LD or AUX input terminals of your stereo amplifier. Do not connect them to your amplifier PHONO input. (Two Audio cables are supplied with the player.)
- 4. S-VIDEO OUT TERMINAL:** The player can be connected via this connector to an AV monitor or television equipped with an S-VIDEO INPUT terminal. The Audio connections from Audio OUT on the player to Audio IN on the monitor must also be made.
- 5. VIDEO OUT TERMINAL (RCA Jack):** This terminal outputs an NTSC video signal and is used for connecting the player to a color video or TV monitor that has a video input jack. (A video cable is supplied with the player.)
- 6. CHANNEL SELECTOR (CH 3 / CH 4):** This switch changes the channel of the internal RF converter. Set this to the channel that is not used for TV broadcasts in your area.
- 7. VHF OUT TERMINAL (75 Ω F-type jack):** Connect this terminal to the VHF antenna terminal of your TV set. (An Antenna Cable is supplied with the player.)
- 8. ANTENNA TERMINAL (75 Ω F-type jack):** Connect the coaxial cable (75Ω) from the VHF TV antenna to this terminal. (An adapter to connect the coaxial cable is supplied with the player.)
- 9. SAFETY POWER CORD:** This is a 3-line power cord with a 3-pronged power plug. Insert the power plug into a wall outlet (120V, 50/60 Hz). Make sure the wall outlet has a ground terminal. Do not defeat the ground plug by using an inappropriate connector.

CLD-V2400 — Front Panel View

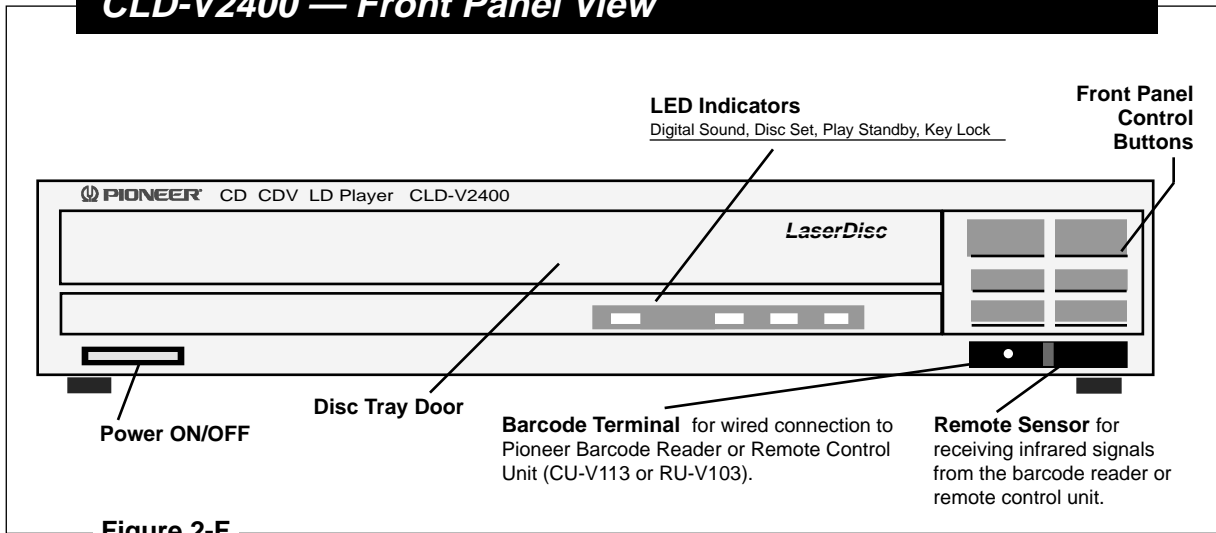

Figure 2-F

CLD-V2400 — Rear Panel View

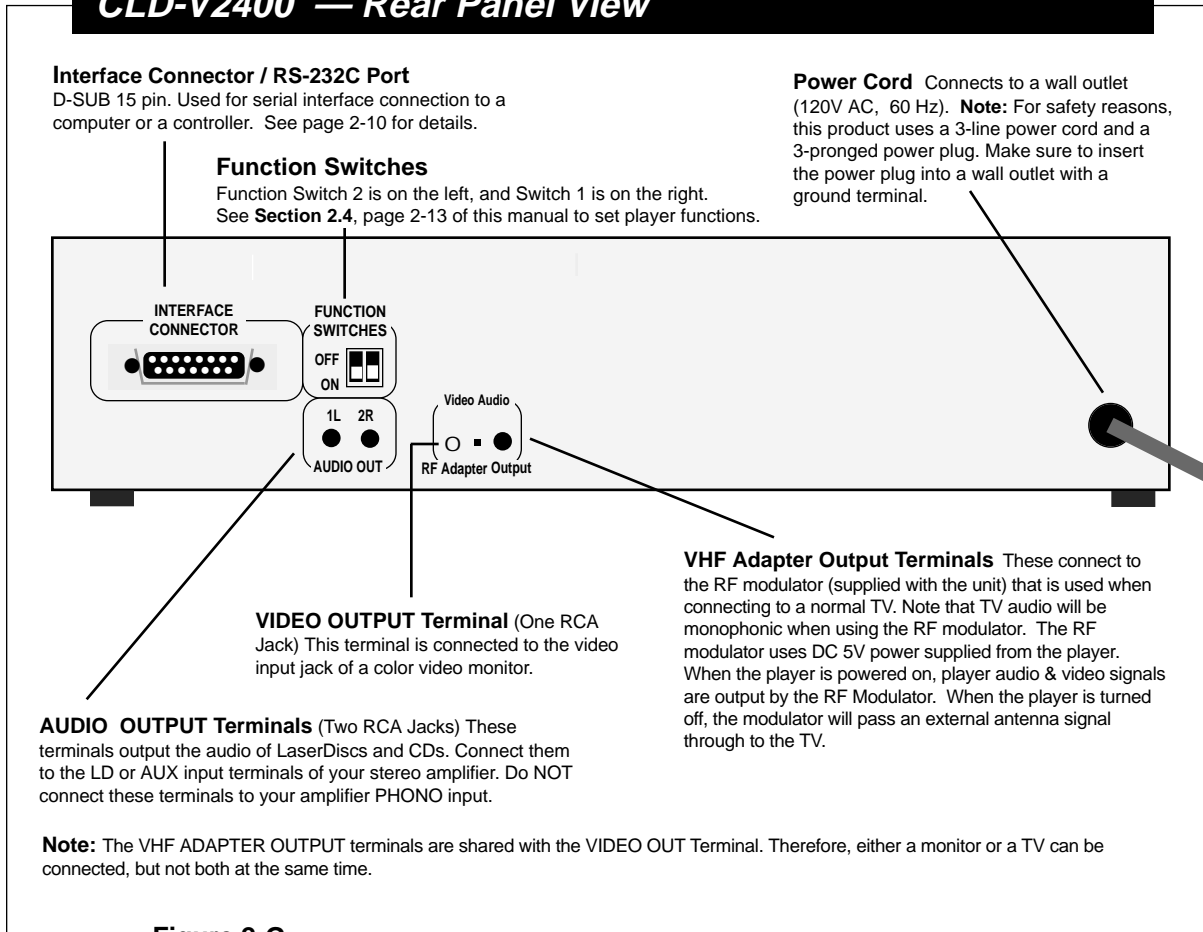

Figure 2-G

2.3 Interfaces

This section describes the player interfaces that receive control signals:

- The **remote sensor** receives infrared signals from the CU-V113 or RU-V103 remote control units or a Pioneer barcode reader. (See **Section 2.3.1**, below for details.)
- The **Barcode Terminal** receives signals from a wired connection to either the remote control unit or the barcode reader. (See **Section 2.3.1**, page 2-9, for details.)
- The **RS-232C port** receives signals from an external computer via the appropriate RS-232C cable. (See **Section 2.3.2**, page 2-10.)

Please see the Front and Rear View diagrams of the players to locate each interface:

- **CLD-V2600** — **Figures 2-D** and **Figure 2-E** on page 2-5 & 2-6.
- **CLD-V2400** — **Figures 2-F** and **Figure 2-G** on page 2-7.

2.3.1 Remote Sensor and the Barcode Terminal

The remote sensor receives input via infrared signal and the Barcode terminal receives input via a wired connection. Both the remote sensor and the Barcode Terminal can receive signals from either a Pioneer Barcode Reader or from the remote control unit. Both Barcode and remote control commands are transmitted in serial data streams.

Note: The infrared sensor and the Barcode Terminal cannot be used simultaneously.

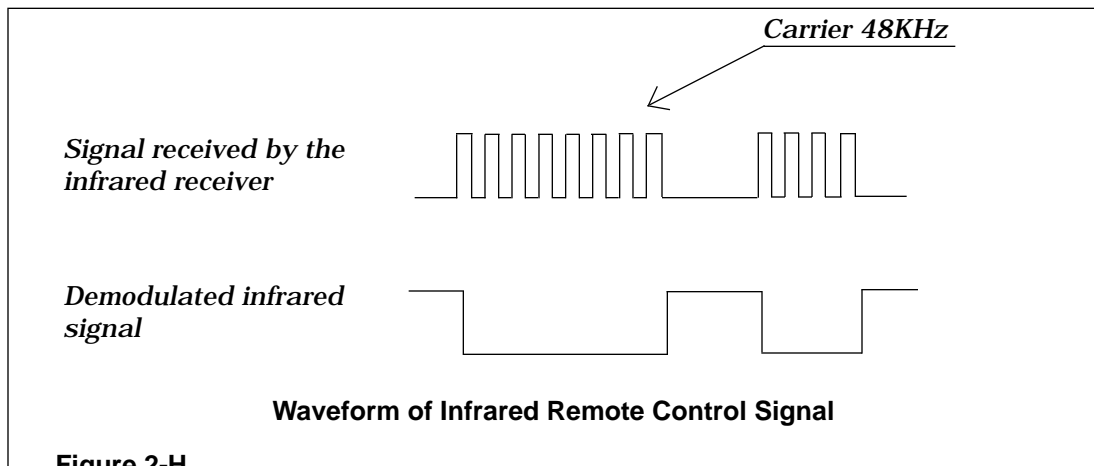

The remote sensor receives the RCU signals on a 48-KHz carrier, removes the carrier, shapes the waveform, and outputs the shaped waveform. See **Figure 2-H**. A stereo or mono mini-plug cable (**Figure 2-I**, next page) can be used to input a signal to the Barcode terminal, when a wired connection from the remote control unit or the Barcode Reader is made.

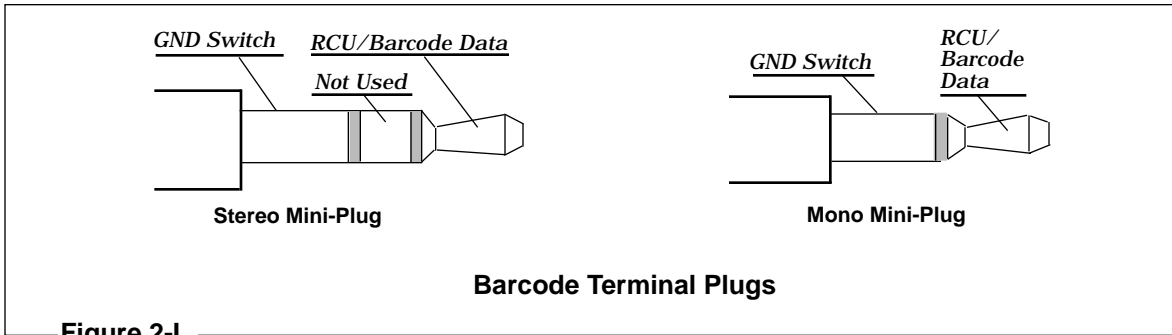

Figure 2-I

The CU-V113 or RU-V103* remote control can each be used with a cable that has a stereo or mono mini-plug on each end. The Barcode Reader is packaged with a wire that has a stereo mini-plug on the end that connects to the reader and a mono mini-plug on the end that connects to the player. RCU or Barcode Reader signals transmitted via cable are input in the shape of the waveform shown in **Figure 2-J**, below.

* Neither the CU-V113 nor the RU-V103 remote control is packaged with a cable to connect to the Barcode Terminal.

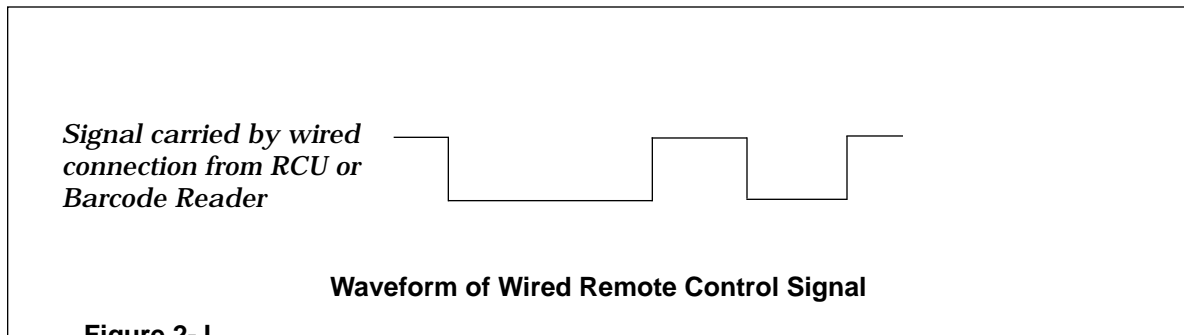

Figure 2-J

The Ground Switch connection is used to make either the remote sensor or the Barcode Terminal active. The Barcode Terminal becomes active when the signal is low (or is closed). The remote sensor becomes active when the signal is high (or is open).

RCU input is decoded by the RCU Decoder. See **Figure 2-K** on the next page and **Appendix H, CLD-V2600 & CLD-V2400 Internal Player Controls** for details; page H-3 for Control Block Diagram.

The RCU Decoder interprets both commands and responses from an input device. **NOTE:** The player's RCU decoder cannot simultaneously decode signals received via remote sensor and Barcode Terminal.

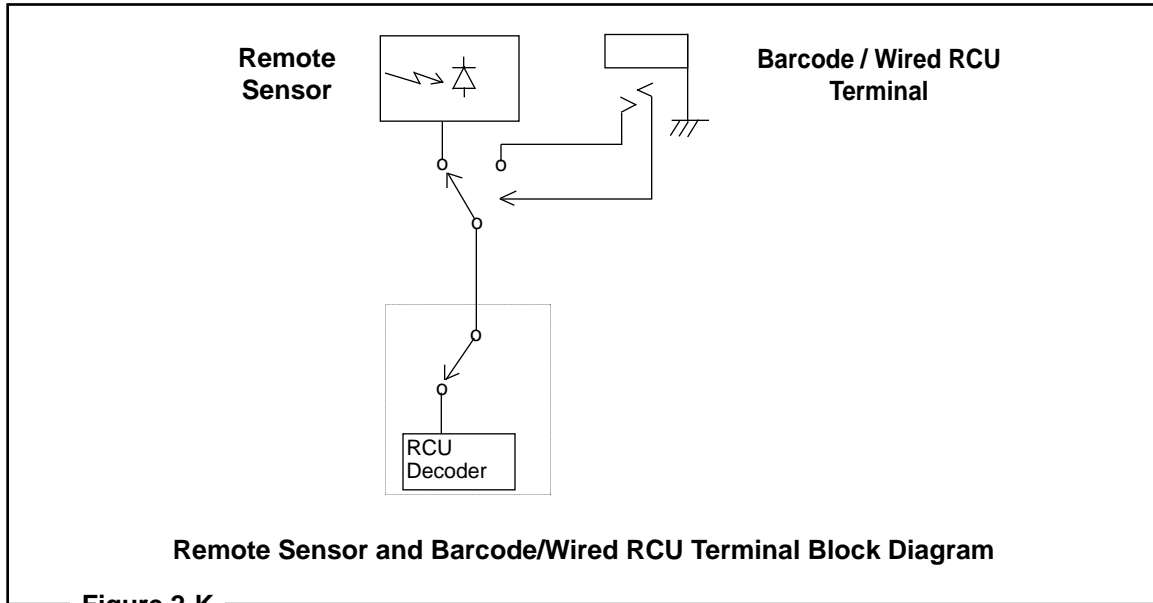

Figure 2-K

2.3.2 RS-232C Interface Connector

Both the CLD-V2600 and the CLD-V2400 can be controlled by a computer connected to the RS-232C port on the back of the player. This section gives specific information about: 1.) The RS-232C Connector; 2.) The pin outs of the Serial Interface; 3.) Signal Characteristics; 4.) Connection to a computer.

1) The RS-232C Connector:

15-pin D-SUB connector, female, on the player.

15-pin D-SUB connector, male, on the cable.

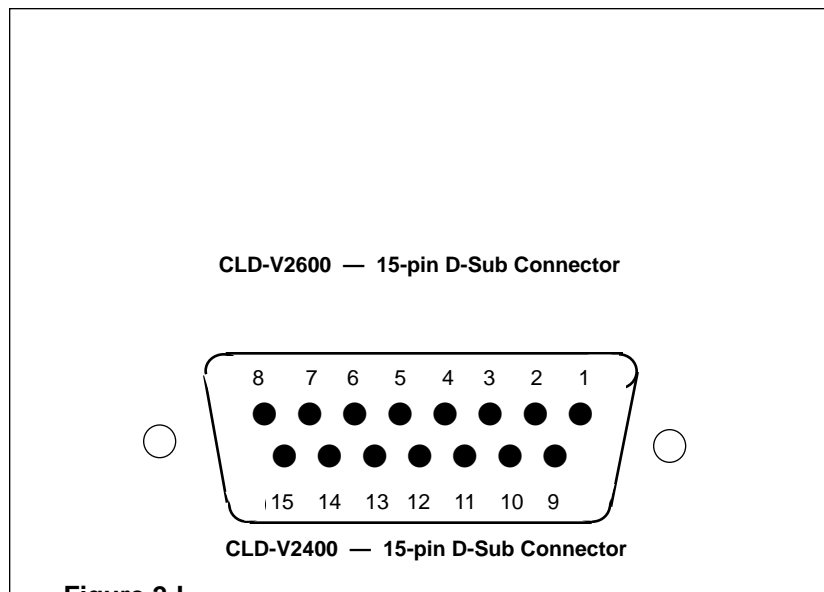

Figure 2-L

2) Serial Interface Pin Outs

Pin #	Terminal	Input/Output	Level
1	GND		
2	TXD	OUTPUT	RS-232C
3	RXD	INPUT	RS-232C
4	DTR	OUTPUT	+5V PULLUP
5	No Connection		
6	No Connection		
7	No Connection		
8	No Connection		
9	TXD	OUTPUT	TTL
10	RXD	INPUT	TTL
11	GND		
12	No Connection		
13	No Connection		
14	No Connection		
15	GND		

Figure 2-M

3) The Serial Interface

The Signal Level

RS-232C or TTL levels can be used. The signal level for the RS-232C is $\pm 12v$ and the TTL levels are 0 to 5v, with 5v having a logic "1" value. Signals in both levels cannot be used or connected at the same time.

The Data type

- Parity bit : No parity.
- Data length : 8 bits.
- Stop bit : 1 bit.

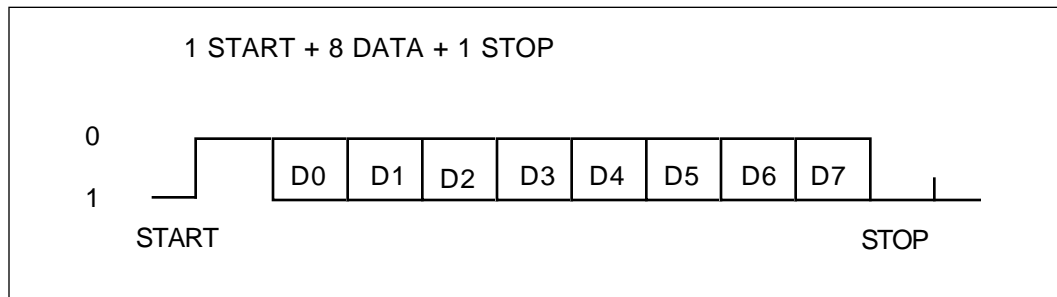

Figure 2-N

The Transmission speed

4800, or 1200 baud can be selected by using the Dip Switch 2 on the back of the player: Down = 1200 BAUD; UP = 4800 BAUD. The factory default is UP= 4800 BAUD. The BAUD rate can also be set by sending Level III commands to Register C.

4) Connection to a Computer

The player can be connected to a computer via the RS-232C port as shown below. It is connected with three lines: One line transmits commands from the computer to the player to control operations. Another line transmits status responses from the player to the computer. The third line is Ground.

The player does not use hardware handshaking. Therefore, control or “handshaking” lines other than TxD and RxD are not required, even if the computer provides them.

Some computers, however, may require hardware handshaking. The player makes a line available to be used, as needed, by the computer. The DTR signal is always pulled high internally, within the CLD-V2600 & CLD-V2400.

The player is connected to the RS-232C port of the computer as follows:

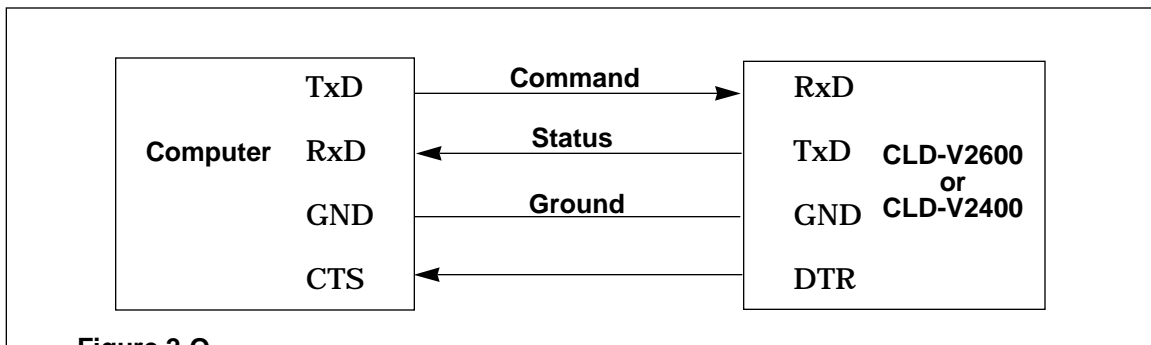

Figure 2-0

See **Appendix C** for specific interface cable pin configurations to use to connect various computers to the CLD-V2600 or to the CLD-V2400.

2.4 Function Switches

The CLD-V2600 videodisc player has four physical dip-switches, #1-4, on the rear panel of the player and the CLD-V2400 has two, #1 & 2. (See diagram below.) These are used to set several function parameters after the power is turned on. All switches are UP (OFF) when the players are shipped from the factory. The factory defaults are as follows: Switch 1: Power On/Load Start is OFF; Switch 2: BAUD rate is 4800; Switch 3: SQUELCH is BLUE; Switch 4: Not Used.

Function Switch Settings					
			<p>Switches 1 & 2 are available on both the CLD-V2600 and the CLD-V2400. Switches 3 and 4 are only available on the CLD-V2600. To initialize the player with new settings, power down and then power on the player again.</p>		
Player	Switch #	Function	On (Down)	Off (Up)	Factory Setting
2600 & 2400	Sw 1	Load Start Power-On Start	Auto	Off	Off
2600 & 2400	Sw 2	BAUD Rate	1200	4800	4800
CLD-V2600 only	Sw 3	Background Color	Black	Blue	Blue
CLD-V2600 only	Sw 4	Not Used			

Figure 2-P

Sw.1: With this switch ON, playback begins automatically when the disc table is inserted or when the power is turned ON with the disc previously loaded. This switch is set to OFF/UP at the factory.

Sw.2: The serial communication speed (BAUD rate) can be set to either 1200 or 4800. With this switch ON the speed is 1200 BAUD and with the switch OFF, the speed is 4800. The factory set value is 4800 BAUD (OFF/UP).

Sw.3: The background color or "squelch" on the monitor can be set to BLUE or BLACK. This switch is set OFF/UP at the factory, providing a BLUE Squelch.

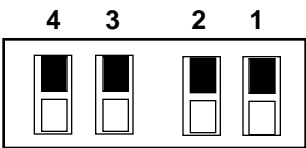
Sw.4 Not used.

NOTE: These settings can be modified by entering data into Register C from a computer via the RS-232C port. (See **Section 4.7.6 Register Control Commands, Register C Set**, page 4-43.) Settings for Switch 1, Load Start, Power-On Start and Switch 2, BAUD Rate, and Switch 3 Background Color can be modified in Register C.

2.5 On-Screen Displays in Manual Mode

The CLD-V2600 and the CLD-V2400 display messages on the monitor using their own internal character display. There are four designated areas on the screen that provide the user with important status information. Three of these (Areas 1, 2 and 3) are accessed in Manual Mode. See **Figure 2-Q** below.

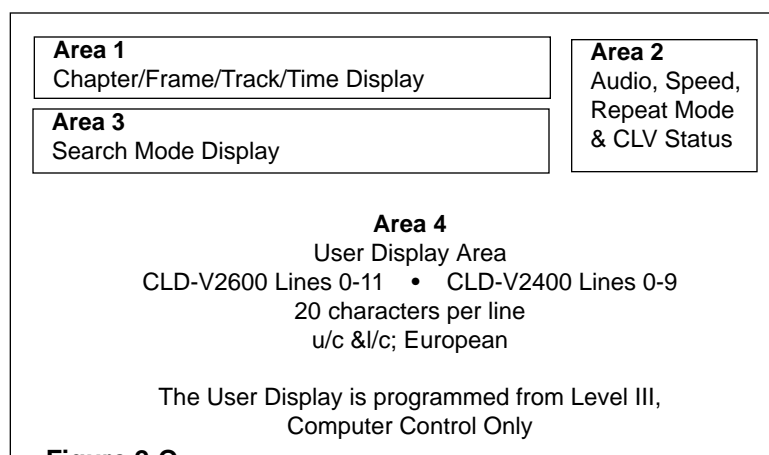

Area 1 displays the Chapter / Frame / Track / Time Display. Area 2 displays the status of the player's audio and speed settings, repeat mode, and CLV disc play — indicating some buttons (such as Multi Speed) are invalid because a CLV disc is playing. Area 3 indicates the *Mode* that has been set for the search flag, depending on the type of disc being played. **Note:** Area 4 (lines 0-11 on the CLD-V2600 and lines 0-9 on the CLD-V2400) can be programmed under computer control with special user messages. See **Section 4.7.6 Register Control Commands, Register A Set**, pages 4-39 to 4-41, for details; also see **Technical Bulletin # 141, On-Screen User Display**.

2.5.1 Area 1: Chapter / Frame / Track / Time Display

Pressing the DISPLAY button on the remote control will cause the chapter and frame numbers (LD CAV discs) or chapter and time numbers (LD CLV discs), track and absolute time numbers (CDs) or track-index and elapsed time number of current track (CDs) to be displayed in the upper left corner of the video monitor.

NOTE: Chapter numbers will be displayed only if they have been encoded on the LaserDisc at the customer's request.

NOTE: Time number frame value access is possible from Level III on the CLD-V2600 & CLD-V2400 with CLV discs, however, frame values are not displayed on screen. See "Frame Set", page 4-21. While both players are fully interactive with CAV discs and hold CAV still frames, neither player will display a still frame from a CLV disc. (The Pioneer LD-V8000 player is the only one in the industry to display CLV still frames.)

While playing a CAV Laser Disc, the player displays chapter and frame numbers:



Figure 2-R

The two digit chapter number and five digit frame number are displayed on the top line of the monitor (display line 0) as in the example in **Figure 2-R**. The two digits indicating a chapter number are not displayed if chapter numbers have not been encoded on the disc.

While playing a CLV disc, the player displays chapters and time numbers as follows:

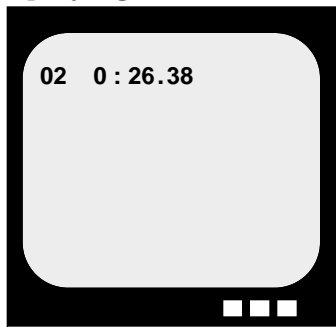

Figure 2-S

The two digit chapter and a five digit time number are displayed on the top line (display line 0) in **Figure 2-S**. The two characters indicating a chapter number are not displayed if chapter numbers have not been encoded on the disc.

While playing a CD, the player displays the current track and absolute time number of the disc or the current track, index and elapsed time of the current track:



Figure 2-T

The two digit track number, 00-99, and a four digit absolute time number (minutes and seconds, 00-99 and 00-59) are displayed on the top line (display line 0) in **Figure 2-T**. Or the two digit track number 00-99, two digit index number 01-99, and the elapsed time number of the current track (minutes and seconds) are displayed on line 0.

Using either the remote control unit packaged with the player, the CU-V113, or the optional RU-V103, press the Display button once to display the current track number and total elapsed time of the disc.

Press the Display button a second time to display the current track and index numbers and the number indicating the total elapsed time of the current track.

2.5.2 Area 2: Status Displays for Audio, Speed Set, Repeat Mode & CLV Indicator

Audio commands are sent to the player by pressing the AUDIO button on the remote control unit. Speed Set commands are sent by pressing the remote control SPEED Buttons (Up or Down). *Repeat Mode* is set by pressing the REPEAT button. The *Audio* or *Speed* or *Repeat Mode* status of the player is displayed in Area 2, the upper right corner of the video monitor. See **Figure 2-Q**, on page 2-14.

Audio Status

Press the AUDIO button on the remote control unit to display the current audio output status on the two top display lines (display lines 0 and 1) in the upper right hand corner of the monitor. See **Figure 2-U** and **Figure 2-V**, below.

Digital	Analog
* Digital Stereo	* Analog Stereo
* 1/L	* 1/L
* 2/R	* 2/R
* Audio Off	*Audio Off

Figure 2-U



Figure 2-V

The first item, Digital or Analog, indicates whether audio output is to come from the analog or digital channels of the videodisc. Then, the following options are available: Stereo, 1/L, and 2/R and Audio Off. Digital, Analog and the options may be toggled through by pressing the AUDIO button repeatedly. Digital Stereo is the default setting, if digital audio is encoded on the disc.

NOTE: The Digital Sound indicator on the front of the CLD-V2400 player will be lit if the disc being played is encoded with digital audio. On the CLD-V2600 player, the words “Digital Sound” will be illuminated in the front panel display window.

Speed Status

To set the playback speed of the player, press MULTI-SPEED SET (“Up” or “Down” on the remote control unit). The speed setting will be displayed in the upper right corner of the monitor on the first display line (display line 0). See the example below in **Figure 2-W**. The display in this example indicates the speed of the player in *Multi-Speed* will be 1/4 speed. During Multi-Speed playback, audio is muted.

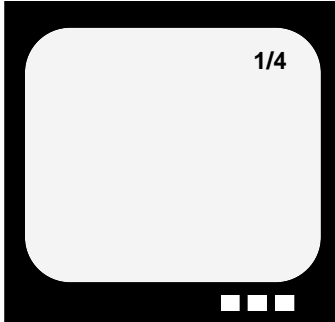

Figure 2-W

NOTE: MULTI-SPEED SET is not available on this player with CLV LaserDiscs or with CDs. If there is a CLV disc in the drawer when the MULTI-SPEED SET button is pressed, the letters CLV appear in the upper right hand corner of the monitor, and no speed change is set. If there is a CD in the drawer when the MULTI-SPEED SET button is pressed, the player does not respond.

The table below shows the speeds as they are displayed and corresponding speeds. (See **Figure 2-X**.)

Displayed Code	Speed Set	
x3	180 / 60	3x normal speed
x2	120 / 60	2x normal speed
x1	60 / 60	normal speed/default*
1 / 2	30 / 60	1/2 x normal speed
1 / 4	15 / 60	1/4 x normal speed
1 / 8	8 / 60	1/8 x normal speed
1 / 16	4 / 60	1/16 time normal speed
STEP 1	2 / 60	1 frame per second
STEP 3	1 / 60	1 frame every 3 seconds

Figure 2-X

*Normal /Default Speed is 30 frames per second.

Repeat Mode Status

When the REPEAT button is pressed on the remote control, the player displays three repeat options for LaserDiscs: Repeat Side, Repeat Chapter or Auto Return. Repeat options for CDs are Repeat Side, Repeat Track and Auto Return. All of the repeat options may be toggled through by pressing the REPEAT button several times. Repeat Mode Status is displayed in Area 2, the upper right corner of the monitor.

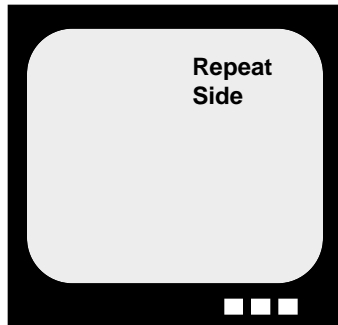

Figure 2-Y

The Repeat Mode status is displayed in Area 2, the upper right corner of the monitor. The CLV display, described on the next page, is also displayed in Area 2.

The Repeat button functions only during playback. Default at Power-On is *Repeat Side*.

- When **Repeat Side** is selected, the player will play through the video material* to the end on a CAV or CLV LaserDisc, or through the audio material on a CD, and then the player will search to the beginning of the disc and play it again.
- **Repeat Chapter** is selected during CAV or CLV LaserDisc playback of a particular chapter. The player will play through the end of the chapter*, when it reaches the chapter's end, it will search to the beginning of the chapter and play it again. When *Repeat Chapter* or *Repeat Track* is selected, the player will repeat the selected chapter or track continuously until a Search command is sent to the player or until the Repeat Mode is changed. Powering off the player or sending an RS 232C command puts the player back into *Repeat Side* mode.
- **Repeat Track** is selected during CD playback of a particular track. The player will play through the end of the track and when it reaches the track's end, it will search to the beginning of the track and play it again.
- When **Auto Return** is selected, the player will play through the video material* to the end of a CAV or CLV LaserDisc or through the audio material on a CD. When it reaches the end, the player will spin down the disc and enter *Park Mode*.

* If a picture stop is encountered during playback of a CAV disc, the player will stop and hold a still frame at that location until it receives the next motion command. Picture stops are often encoded on the first frame of a chapter but they also may be encoded at other locations. Picture stops cannot be encoded on CLV discs. *Repeat Side* and *Repeat Chapter* do not override picture stops.

CLV Display

When a CLV disc is playing, the player cannot perform certain CAV special effects commands such as STILL/STEP or MULTI-SPEED SET or MULTI-SPEED. If these buttons are pressed on the remote control unit during CLV play, the letters CLV will appear in Area 2, the upper right hand corner of the monitor, indicating that a CLV disc is playing and that certain commands (STILL/STEP FORWARD, MULTI-SPEED, etc.) are unavailable. The commands are also unavailable if a CD is playing, but no indicator will appear on the monitor.

2.5.3 Area 3: Argument Display

An “argument” displayed in *Manual Mode* is the numeric information preceding a search or play command that provides the player with the exact location (address) on the disc to search or play. It is displayed in the upper left corner of the video screen on the second display line (Line 1) after a search flag has been set by pressing the Chapter/Frame Track/Time button on the remote control, and after the numeric keys and then the SEARCH or PLAY button on the remote control are pressed (e.g. Frame Mode, 1000 SEARCH or Track Mode, 2 PLAY).

The numbers are displayed according to the type of address flag that has been set: Chapter, Frame, Track or Time. (See **Figure 2-R - 2-T**) The CLD-V2600 & the CLD-V2400 players search or play to frame numbers on a CAV disc; to chapter numbers on a CAV or CLV disc that has chapters encoded on the disc; to time numbers on a CLV disc; and to track, or time numbers on a CD. The default setting is Chapter Search on LDs and Track Search on CDs.

2.5.4 Area 3: Address Flag Display

The proper address *flag* must be set to send the correct “address” to the player. The address flag indicates the location to which the player will Search or Play. The Search address is displayed on the monitor according to the address flag that has been set. On the CU-V113 and the RU-V103, the button labeled CHAP/FRAME/TRACK/TIME is used to select the address flag (chapter, frame or time number for LaserDiscs, or track, or time for CDs). After the address flag is selected, send the location to which the player will search or play. (For more information, see **Section 3.2.2, #12 Search** on page 3-12 and **#13 Chapter/Frame/Track/Time**, on page 3-13.)

NOTE: The Chapter/Frame/Track or Time number address flag must be set before a Search or Play command is sent from a computer. Neither the address flag, nor the characters of an address will be displayed on the video screen during a computer transmitted Search or Play. See **Section 4.5** on page 4-7 & 4-8 for more information on Level III Command Formats. For specific Level III Player Control Commands used to set the desired search flag, see **Section 4.7** on page 4-21 to 4-23. Notice, it is possible to set address flags for Index and Block levels under computer control.

NOTE: If address numbers are entered incorrectly in *Manual Mode*, press the CLEAR button to remove them, re-enter the numbers and then press SEARCH or PLAY.

NOTE: It is not possible to search to the Index level with the remote control unit. It is possible to search to indices by creating and scanning Barcode CD commands. See **Appendix E, Barcode CD Commands and Logo.**

Also, while it is possible to play distinct segments using LaserBarcode or Barcode CD commands, it is not possible to play to distinct segments using the remote control unit. It is possible to play through the disc to a specific end frame, chapter or time number by indicating the address prior to a PLAY command, SEARCH command, or Multi-Speed Command using the Remote Control Unit. Segment plays are also programmable under Level III computer control.

3. Manual Control — Level I

3.1 Front Panel Control

3.2 Remote Control

3.3 Barcode Control

CHAPTER

3

CLD-V2600

& CLD-V2400

LEVEL I & III

USER'S MANUAL

Programmer's Reference Guide

3 MANUAL CONTROL — Level I

The CLD-V2600 and the CLD-V2400 can be manually controlled by using the front panel buttons, the remote control unit CU-V113, packaged with the player, or the optional remote control unit RU-V103 sold separately, or a Pioneer Barcode Reader.

3.1 Front Panel Buttons

There are eight control buttons on the front of the CLD-V2600: STOP-OPEN/CLOSE, PAUSE, PLAY, DISPLAY ON/OFF, STILL/STEP (Forward and Reverse), SKIP (Forward and Reverse). There is also a two speed SCAN control shuttle dial on the front. There are six control buttons on the front of the CLD-V2400 player: STOP-OPEN/CLOSE; PLAY; SKIP (Forward and Reverse); SCAN (Forward and Reverse). This section describes how to use these buttons in *Manual Mode* for Level I control of the players.

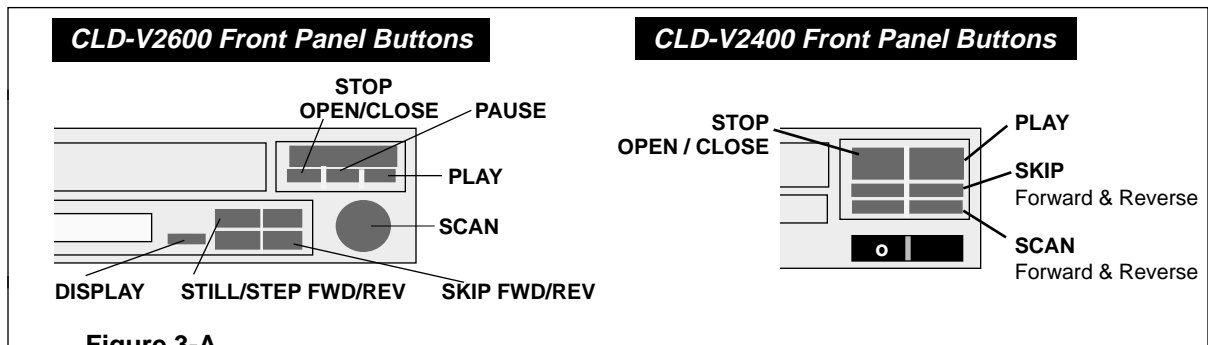

Figure 3-A

3.1.1 STOP - OPEN/CLOSE - CLD-V2600 & CLD-V2400

Function: Pressing this button opens or closes the disc tray door. If a disc is playing, pressing this button once spins down the disc, pressing it a second time opens the door and ejects the disc tray.

Explanation: The operation performed when the STOP-OPEN/CLOSE button is pressed depends on the active mode of the player.

In Spin Up or Random Access Mode

If the OPEN/CLOSE button is pressed when the player is in *Spin Up* or *Random Access Mode*, the active mode of the player changes to *Reject Mode* and the player enters *Park* when disc rotation stops. (Press the button again to open the disc tray.)

In Spin Down Mode

If this button is pressed when the player is in *Spin Down Mode*, processing waits until the player enters *Park*. When the player enters *Park*, the disc tray opens.

In Park Mode or while door is closed

If this button is pressed when the player is in *Park* or while the disc tray is closed, the player opens the disc tray.

In Door Open Mode or while door is opened

If this button is pressed when the player is in *Door Open Mode* or while the disc tray is opened, the player closes the disc tray.

3.1.2 PLAY - CLD-V2600 / CLD-V2400

Function: This button is used to start or resume playback of the video/audio material on the disc.

Explanation: Pressing this button has different effects, depending on the active mode of the player:

- If this button is pressed while the disc tray door is opening or when the door is open, the player closes the door. After the door is closed, the player enters *Park Mode* and then determines whether a disc is in the drawer. If there is no disc in the drawer, the player does nothing. If there is a disc in the drawer, it proceeds through the operations described in *Park Mode*.
- In *Park Mode* the player determines whether or not there is a disc in the drawer. If there is no disc, the player does nothing. If there is a disc, the player spins up the disc. When *Spin Up Mode* ends, the player enters *Random Access Mode* and begins playing the disc.
- In *Random Access Mode*, the player starts or resumes playing the disc.
- When a search is in progress and the PLAY button is pressed, the player starts playing the disc after the search is completed.

3.1.3 PAUSE - CLD-V2600

Function: Pressing this button causes the player to cease playback temporarily.

Explanation: In *Pause Mode*, video is squelched. Press the PLAY, STEP FWD/REV or SKIP FWD/REV button to exit *Pause Mode*. The PAUSE button does not toggle PAUSE ON and OFF. PAUSE can be used in *Random Access Mode*, during LD or CD playback.

3.1.4 SKIP FWD / REV - CLD-V2600 / CLD-V2400

Function: Pressing SKIP FORWARD makes the player jump forward one chapter or track at a time. If SKIP FORWARD is pressed repeatedly, it will skip forward the corresponding number of chapters. Pressing SKIP REVERSE replays the chapter or track currently playing. If SKIP REVERSE is pressed repeatedly before the player ends its search and starts to play, the player will skip back the corresponding number of chapters or tracks.

Explanation: This button is effective only in *Random Access Mode*. During LaserDisc playback, these buttons will not function unless chapters have been encoded on the disc. The player will hold a still frame if a CAV LaserDisc encoded with chapters is playing; if a CLV LaserDisc encoded with chapters is playing, it immediately plays. When a CD is playing, the player will Skip Forward to the next track or Skip Reverse to the previous track and immediately play the material.

NOTE: While the player is skipping to the chapter selected on a LaserDisc, video and audio are squelched. While skipping to a selected track on a CD, audio is squelched.

3.1.5 SCAN FWD / REV Button - CLD-V2400

Function: Pressing these buttons on the CLD-V2400 makes the player scan forward or reverse rapidly.

Explanation: The CLD-V2400 player scans as long as this button is pressed. The scanning speed of the CLD-V2400 is about 40x normal speed on CAV discs; approx. 25x normal speed on CLV discs.

SCAN FWD/REV Dial — CLD-V2600

Function: Rotating the SCAN CONTROL on the CLD-V2600 makes the player scan forward or reverse rapidly.

Explanation: On CLV discs, slightly rotate the dial for a clear picture scan (approx. 15x normal speed). Rotate the dial further for a normal CLV scan (approx. 20x normal speed). On CAV discs, rotate the dial slightly to scan at 9x normal speed. Rotate fully to scan video at 32x normal speed. Both CAV scan speeds present clear picture scans.

NOTE: Audio is squelched during a scan on a LaserDisc. Audio is not squelched during a scan on a CD. When the scan button or dial is released, the player reverts to the mode it was in before scanning.

NOTE: If either player is in the process of searching to a target address when the SCAN button is pressed or when the SCAN CONTROL dial is turned, the player completes the search and ends in a still frame (CAV) or immediately plays (CLV or CD).

3.1.6 STILL/STEP FWD / REV (CAV LaserDiscs Only) - CLD-V2600

Function: When a CAV disc is playing, pressing these buttons makes the player hold a still frame and step one frame forward or reverse. Pressing these buttons has no effect when a CLV disc is playing, and the letters CLV appear in the upper right corner of the screen. They also have no effect when a CD is playing.

Explanation: This command is effective only when the player is in *Random Access Mode* and a CAV LaserDisc is playing. The result of sending this command differs, depending on the operation being performed when it is sent. *During a search:* After the search, the player holds a still frame. *During a still operation:* The player performs step forward or reverse then holds a still frame. *During any other operation:* The player holds a still frame. **NOTE:** Audio is squelched during still frame, step forward or step reverse.

3.1.7 DISPLAY ON/OFF - CLD-V2600

Function: Pressing this button enables or disables the display of current chapter number and frame number (CAV discs), the current chapter number and time number (CLV discs), or the current track and time number (CDs) or track, index and time number (CDs). These numbers indicate the current location on the disc and they are displayed in the upper left corner of the monitor. The display may be toggled ON or OFF.

3.2 Remote Control

The CLD-V2600 and the CLD-V2400 are packaged with a remote control unit, the CU-V113. Also, an optional remote control unit, the RU-V103, can be purchased separately and used with this player. The CU-V113 and the RU-V103 are identical remotes, and are used to send commands to the player via an infrared signal.

Note: Both the CU-V113 & RU-V103 are “wireless” remotes; but they are equipped with a mini-plug jack and can be used with a separately purchased stereo or mono mini-plug cable to provide a wired connection to the Barcode Terminal on the front of the player. Both remotes also can be used to control the following Pioneer industrial videodisc players: the LD-V8000, LD-V4400, LD-V2200, LD-V2000.

3.2.1 Remote Control CU-V113 & RU-V103

The CU-V113 & RU-V103 have easy-to-use functions and large flat keys. Their range of player control is limited to Level I, basic manual controls. (See **Figure 3-C**)

3.2.2 Description of Remote Control Functions

Each remote control unit button associated with a corresponding command that may be used to control the CLD-V2600 or the CLD-V2400 is described in **Figure 3-B** below and see **Figure 3-C** on page 3-5. Also, refer to the text that follows Figure 3-C. Refer to **Appendix B** for descriptive illustrations of the CU-V113 & RU-V103 remote control units.

List of Remote Control Functions for Use with the CLD-V2600 & the CLD-V2400

	Function	LD	CD	Page #
1	REJECT	✓	✓	3-4
2	PAUSE	✓	✓	3-4
3	PLAY	✓	✓	3-6
4	REPEAT MODE	✓	✓	3-7
5	STILL/STEP REV / FWD	CAV Only	—	3-9
6	DISPLAY	✓	✓	3-9
7	SCAN REV/ FWD	✓	✓	3-9
8	AUDIO	✓	✓	3-10
9	SPEED DOWN/UP	CAV Only	—	3-11
10	CLEAR	✓	✓	3-12
11	MULTI REV/FWD	CAV Only	—	3-12
12	SEARCH	✓	✓	3-12
13	CHAPTER / FRAME TRACK / TIME	✓	✓	3-13

Figure 3-B

CU-V113 / RU-V103 Remote Control:

LEVEL I CONTROL

REJECT: Ceases playback and spins-down the disc.

PAUSE: Ceases playback and displays a squelch screen. Press any motion button to resume.

PLAY: Begins playing a disc, or resumes play.

REPEAT MODE: This button can be pressed to set side repeat, chapter or track repeat, or auto-return.

STILL / STEP (FWD / REVERSE): Press either of these buttons to produce a still video image (CAV Only). Additional presses of the STEP FWD button moves the image forward one frame at a time. STEP REV moves the image in reverse one frame at a time.

DISP: Displays or removes the display of current chapter/frame/track or time numbers on the screen. During CD playback, track numbers with the disc's absolute time location are displayed or track and index numbers are displayed with the elapsed time of the current track.

SCAN (FWD / REVERSE): Press either of these buttons to move quickly forward or backward through the program material on a disc. Rapid scanning continues as long as the button is depressed.

AUDIO: Press this button to select audio output: Digital Stereo, Digital 1/L, Digital 2/R, Audio OFF, Analog Stereo, Analog 1/L, Analog 2/R, Audio OFF. **Note:** CDs output digital audio only.

SPEED (DOWN / UP): Press these buttons to set the speed at which multi-speed play will occur. (CAV only.)

CLEAR: Press this button to CLEAR erroneous inputs or to stop a Search operation.

MULTI-SPEED (REV / FWD): Press this button to initiate Multi-Speed Play forward or reverse in the speed that has been set with the SPEED button. (CAV only.)

NUMERIC BUTTONS (0-9): Use these buttons to enter search points on a disc. Use the CHAP/FRAME TRACK/TIME button to set an "address flag", indicating chapter, frame or time number (LD) or track or time number (CD). Then enter the numeric digits for the location and press Search or Play. Digits 1-9 can also be used for viewer responses during Level III program execution. See Level III Command Input Number Wait (?N).

SEARCH: First set the "address flag" using the CHAP/FRAME TRACK/TIME button. Then specify the number to be searched to by using the digit buttons. Press the

See **Section 3.2.2**, beginning on page 3-6, for details about the use of each specific remote control button.

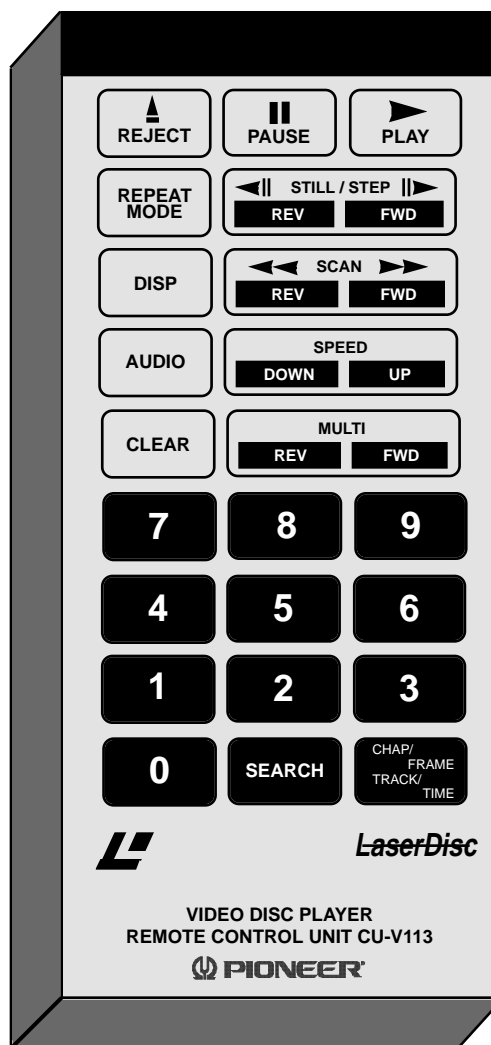

Figure 3-C

SEARCH button to execute. After searching, the player presents a still frame on CAV discs or immediately plays on CLV discs or CDs.

CHAP / FRAME TRACK / TIME: Press this button to set the address flag, indicating how a search will be performed, either by chapter or frame number (CAV), or chapter or time number (CLV) or Track, Time (CD).

Note: The CU-V113 & RU-V103 remote control units are not packaged with a cable for connection to the BC Terminal on the front of the player. A stereo or mono mini-plug cable can be purchased separately, however, and used to provide the wired connection.

1) REJECT

Function: Pressing this button is effective only when the player is in *Spin Up* or *Random Access Mode*. When this command is sent to the player, the active mode of the player is changed to *Spin Down*, processing waits until the spindle stops, and then the active mode is changed to *Park*. **NOTE:** This button cannot be used to open or close the player's disc drawer; it is used to put the player into *Park*.

2) PAUSE

Function: Pressing this button causes the player to cease playback temporarily.

Explanation: The player enters *Pause Mode* when the PAUSE button is pressed. In *Pause Mode*, video is squelched. Press PLAY or any other motion button to exit *Pause Mode*. **NOTE:** The PAUSE button does not toggle PAUSE ON and OFF. To exit *Pause Mode* issue a motion command (PLAY, STEP FWD/REV, MULTI-SPEED FWD/REV) or send a SEARCH command.

3) PLAY

Function: Pressing this button starts the player and plays the LaserDisc or CD.

Explanation: The operation performed when the PLAY button is pressed differs depending on the active mode of the player:

While the disc tray door is opening or when the door is open If this button is pressed while the door is opening or when the door is open, the player closes the door. After the door is closed, the player enters *Park Mode* and then determines whether a disc is in the drawer. If there is no disc in the drawer, the player does nothing. If there is a disc in the drawer, it proceeds through the operations described in *Park Mode* below.

In Park Mode In *Park Mode* the player determines whether or not there is a disc in the disc tray. If there is no disc, the player does not operate. If there is a disc, the player enters *Spin Up Mode* and spins-up the disc. When *Spin Up Mode* ends, the player enters *Random Access Mode* and begins playing the disc.

In Random Mode (when search is not in progress) - The player starts playing disc.

During a search - After the search ends, the player starts playing the disc.

NOTE: Audio is not squelched while the disc is playing. When the lead-out area is reached during normal play, the player automatically spins down the disc, enters *Park Mode* and waits for one of several specific instructions — to reject the disc by pressing the OPEN/CLOSE button on the front of the player, to play the disc again by pressing PLAY on the front of the player or on the remote control, or to turn off the player by pressing the Power-OFF button on the front of the player.

If the "Repeat Side" Function has been set to ON, the player automatically searches to the beginning of the disc and plays it again when lead-out is encountered. See **Section 2.4 Function Switches**, page 2-13.

4) REPEAT MODE

Function: Use this button to automatically repeat playback of one side of a disc; to repeat a specific chapter of an LD; to repeat a specific track of a CD; or to automatically spin down the LD or CD & return to *Park Mode*, when the disc completes playing.

Explanation: When the REPEAT MODE button is pressed, the display will show the currently valid repeat mode. Press the REPEAT MODE button several times to select the following options:

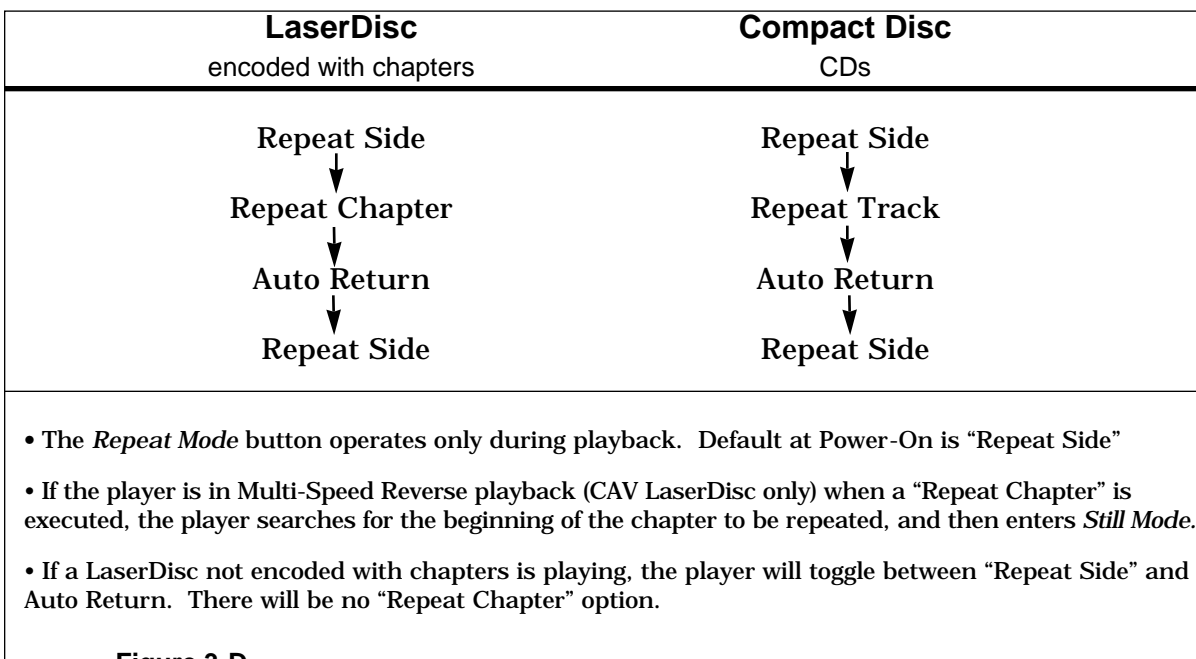

Figure 3-D

Repeat Side: When the end of the disc is reached, the player will search to the beginning of the side and play it again.*

Repeat Chapter: When this mode is selected while a specific chapter is playing, the player will play to the end of the chapter, search to the beginning of the chapter and play it again*, continuously, until a search command is sent, or the *Repeat Mode* is changed.

Repeat Track: When this mode is selected, the player will repeat a specific track of a CD.

Auto Return: When this mode is selected, the player will play the disc side, then spin down the disc and enter *Park Mode*. Issue a Start or Play command to spin up the disc again.

* If a picture stop is encoded on a CAV disc, the player will play to that frame, stop and hold a still frame, until it receives the next motion command. Picture Stops cannot be encoded on CLV discs. Repeat Side and Repeat Chapter commands do not override picture stops.

NOTES on Repeat Mode:

- The REPEAT MODE button functions only during playback.
- When using the RS-232C control, the REPEAT MODE button may not function, depending on the status of player operation.
- *Repeat Chapter Mode* is cancelled when a search command is sent to the player and executed. The player automatically switches to *Repeat Side Mode*.
- When the player is in *Repeat Chapter Mode* and the user sends commands under RS-232C control, the player automatically changes to *Repeat Side Mode*. When the RC command is used to set Register C, the player may be set to *Auto Return*.
- When MULTI-SPEED REVERSE playback (CAV Only) is selected while the player is in *Repeat Chapter Mode*, the player will play backwards, at the speed indicated, to the beginning of the chapter and then will hold a still frame. When MULTI-SPEED FORWARD (CAV Only) is selected in *Repeat Chapter Mode*, the player plays at the speed indicated to the end of the chapter, returns to the beginning of the chapter and immediately replays the chapter again in the speed that has been indicated.
- When the player searches to a chapter on a CAV disc, it will hold a still frame. If *Repeat Chapter* is selected and there is no picture stop encoded within the chapter, the player plays through the chapter, returns to the first frame of the chapter to be repeated, and immediately plays the chapter again.

On a CLV disc, the player will search to a chapter and play it immediately. If *Repeat Chapter* is selected, the player will return to the beginning of the chapter and re-play it immediately, until a search command is sent, or until the *Repeat Mode* is changed.

Although sending a Search command will cancel the *Repeat Chapter Mode* and cause the player to enter *Repeat Side Mode*, issuing other commands, such as still, scan, etc. will not cancel the *Chapter Repeat Mode*.

Picture stops cannot be encoded on CLV discs.

5) STILL/STEP FWD / REV (CAV LaserDiscs Only)

Function: When a CAV disc is playing, pressing these buttons makes the player hold a still frame and step one frame forward or reverse. Pressing these buttons has no effect when a CLV disc is playing, and the letters CLV appear in the upper right corner of the screen. They also have no effect when a CD is playing.

Explanation: This command is effective only when the player is in *Random Access Mode* and a CAV LaserDisc is playing. The result of sending this command differs, depending on the operation being performed when it is sent:

During a search - After the search, the player holds a still frame.

During a still operation - The player performs step forward or reverse then holds a still frame.

During any other operation - The player holds a still frame.

NOTE: Audio is squelched during still frame, step forward or step reverse.

6) DISPLAY

Function: Pressing this button enables or disables the display of current chapter number and frame number (CAV discs), the current chapter number and time number (CLV discs), or the current track and time number (CDs) or track, index and time number (CDs). These numbers, indicating the current location on the disc, are displayed in the upper left corner of the monitor.

Explanation: The display may be toggled ON or OFF. If the display is turned ON, the chapter, frame or time numbers (LDs), or track and absolute time numbers (CDs), or track-index and elapsed time number of the current track (CDs) will be displayed on the monitor. If the display is turned OFF, these items will not be displayed.

7) SCAN FWD / REV

Function: Pressing this button performs a rapid forward or reverse scan.

Explanation: Pressing the SCAN FORWARD or REVERSE button is effective only when the player is in *Random Access Mode*. It is not effective if pressed during a search. The scan continues as long as the SCAN button is depressed. After the scan, the player enters the active mode it was in before scanning. If Chapter Repeat (LD) or Track Repeat (CD) has been set, the player will scan until the scan button is released, then repeat the chapter set for chapter repeat. **NOTE:** Audio is squelched during scanning on LaserDiscs, but is not squelched during scanning on CDs. The scanning speed of the player is about 40 times the normal speed.

8) AUDIO

Function: Pressing this button sets the audio switches.

Explanation: The current audio setting is displayed when the audio button is pressed. Pressing this button repeatedly will change the audio status display as shown below. The audio switch data is written into the Audio Control Register.

A LaserDisc may be encoded with digital and analog audio or with only analog audio. The on-screen display shows the outputs that are available depending on the audio that is encoded on the disc that is playing. See **Figure 3-E, Figure 3-F and Figure 3-G** below. **NOTE:** See **Section 2.5.2 On Screen Display — Audio Status** on page 2-16. CDs are encoded with only digital audio. See page 3-11.

LaserDisc encoded with both analog and digital audio:

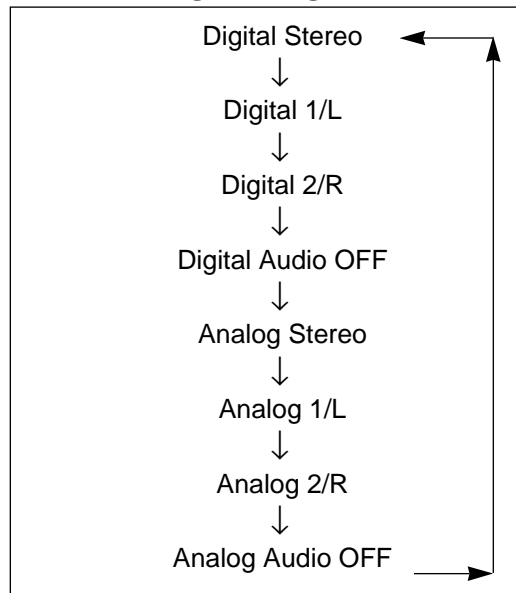

Figure 3-E

LaserDisc encoded only with analog audio:

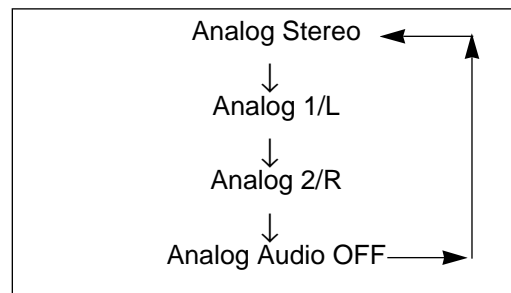

Figure 3-F

The following audio options are available for CDs; or LDs with only Digital Audio.

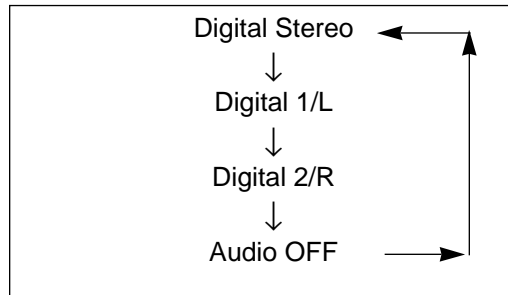

Figure 3-G

NOTE: LDs often have the same audio recorded on *both* the Digital and Analog audio channels so the Analog audio can be output on older players that do not have Digital Audio out, such as the LD-V2200 and the LD-V4200.

9) SPEED SET DOWN / UP (CAV LaserDiscs only)

Function: Pressing this button sets the speed for Multi-Speed play.

Explanation: This command sets the speeds listed below. If the button is pressed once, the current speed setting is displayed on the screen. Press the Fast or Slow button repeatedly to select a faster or slower speed until the desired speed is displayed. The speed is set when the speed data is written into the Speed Register. (See **Figure 3-H**, below, for speed settings.)

SPEED SETTING		Code Displayed on Monitor	Speed (x normal speed)
UP	DOWN		
—	↓	x3	3 x normal speed
↑	↓	x2	2 x normal speed
↑	↓	x1	normal speed (default)*
↑	↓	1 / 2	1/2 x normal speed
↑	↓	1 / 4	1/4 x normal speed
↑	↓	1 / 8	1/8 x normal speed
↑	↓	1 / 16	1/16 x normal speed
↑	↓	STEP 1	1 frame per second
↑	—	STEP 3	1 frame per three seconds

Figure 3-H

* Normal/Default Speed is 30 frames per second.

10) CLEAR

Function: Pressing CLEAR will clear an argument input from the remote control unit or stop a search operation.

Explanation: When the CLEAR button is pressed while an argument is being input, all arguments are cleared and the displayed arguments are removed from the screen. If this button is pressed during a search, the search is stopped and the player holds a still frame (CAV). If the CLEAR button is pressed during a search while a CLV LaserDisc or a CD is being played, the search is stopped and the player begins playing from that point.

11) MULTI-SPEED FWD / REV (CAV LaserDiscs only)

Function: Pressing this button plays the disc forward or reverse at a speed determined by pressing the SPEED SET button.

Explanation: This command is effective only when playing CAV discs in *Random Access Mode*. If this button is pressed while a CLV disc is playing, it will have no effect and the letters CLV will appear in the upper right corner of the screen. If it is pressed while a CD is being played there is no effect.

The player plays forward or reverse at the speed set by using the SPEED DOWN/UP button, if a search is not in progress. If the MULTI-SPEED command is sent while a search is in progress, the player completes the search and immediately starts playing the CAV disc at the speed and in the direction indicated.

NOTE: Audio is squelched (muted) during a multi-speed play. This command is ineffective on CLV LaserDiscs and on CDs.

12) SEARCH

Function: Pressing this button instructs the player to search for the address specified by the argument. When the Search is completed, the player displays a still frame if a CAV LaserDisc is being used. It immediately plays after the Search is completed, if a CLV LaserDisc or a CD is being played.

Explanation: This command searches for the address specified by the argument. Unless another button is pressed during the search, the player holds a still frame (on a CAV LaserDisc) or plays (on a CLV LaserDisc or CD) when the search is completed. If the CLEAR button is pressed during a search, the player stops the search when the CLEAR command is received and holds a still frame (CAV) or plays (CLV, CD).

If the REJECT button is pressed during a search, the player stops the search and enters *Spin Down Mode*. If the PLAY or MULTI-SPEED button is pressed, the player continues the search, then starts to play or starts a multi-speed play (CAV only) after the search. A search is executed when a search address is written into the Search Register. The player then compares the current address with the address in the Search Register and moves the pickup at high speed until the difference between the search address and the current address becomes zero.

NOTE: If an argument is set to a chapter number larger than the ones stored on the LaserDisc, the player searches to the beginning of the final chapter encoded on the disc. If the argument is set to a frame or time number larger than the ones stored on the LaserDisc, the player searches to the final frame number encoded on the disc.

If the argument is set to a track or time number larger than those encoded on a CD, the player will not perform the search, but will continue in the current mode.

13) CHAPTER / FRAME TRACK / TIME

Function: Use this button to set the RCU address specification flag to a frame, chapter, track or time number.

Explanation: The RCU address specification flag is displayed when this button is pressed. The address flag changes from one mode to another, as shown below, when this button is pressed repeatedly, depending on what format disc is playing (CAV or CLV LaserDisc or CD), and what type of information has been encoded on the disc:

CAV discs

CAV discs encoded with chapters:

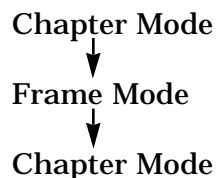

CAV discs without chapters:

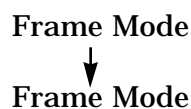

CLV discs

CLV discs encoded with chapters and time numbers:

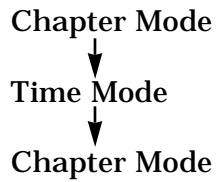

CLV discs encoded with time numbers, without chapters:

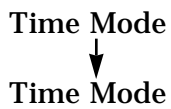

CDs

CDs encoded with track numbers, or track and index numbers, and time numbers:

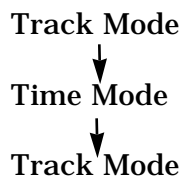

(Refer to **Section 2.5** and **Figure 2-Q** on page 2-14;
also, **Section 2.5.4 Area 3: Address Flag Display**, page 2-19.)

3.3 Barcode Control

Barcodes provide a simple method of quickly retrieving program material from a LaserDisc or from a CD. Scan a LaserBarcode™ with a Pioneer barcode reader and send the command to the CLD-V2600 or the CLD-V2400 to display still frames or play video/audio segments on a CAV disc or chapter segments on a CLV disc. Scan a LaserBarcode 2™ extended barcode to play a time segment on a CLV disc, to play a CAV disc in slow motion, or to access digital audio. Scan a Barcode-CD™ to playback audio segments from a CD. Barcode commands can be scanned using either the Pioneer “AutoScanning” UC-V108BC Barcode Reader, the Pioneer UC-V109 Barcode Reader, or the discontinued UC-V104BC. The barcode commands are then sent to the player via infrared signal through the remote sensor or via a wired connection through the barcode terminal on the front of the player.

3.3.1 LB Original Commands and LB2 Commands

All current Pioneer industrial videodisc players support the original LaserBarcode standard commands. As of August 1, 1992 the LaserBarcode Association officially revised the LaserBarcode standard. This new standard, the LaserBarcode 2 Standard (LB2), has also been adopted by Pioneer. It includes all of the barcode functions available within the original LaserBarcode standard command set and provides “extended commands” for time searches and time segment plays on CLV discs, slow motion playback on CAV discs, and access to digital audio. See **Appendix D** for LB and LB2 command descriptions and sample barcodes.

3.3.2 Barcode CD™ Commands

The Barcode CD command set, used to control the CLD-V2600 and the CLD-V2400 when CDs are playing, consists of four commands. These are Play Track, Play from Track, Play Index and Play Time Segment. See **Appendix E** for sample Barcode CD barcodes and command descriptions. Refer also to **Technical Bulletin #138, CLD-V2400 / CLD-V2600 and CD-Audio Basics**, and **Technical Bulletin #140, CD Barcode and the CLD-V2400/CLD-V2600**.

3.3.3 Creating Barcodes

Bar'n'Coder, Hypercard Barcode Printing Software for the Macintosh, can be used to create original LaserBarcode, LaserBarcode 2, and Barcode CD barcodes. **Barkoder for Windows** is a software package used to create LaserBarcodes, LB2 and Barcode CD barcodes on an IBM PC or compatible running DOS 3.0 and Windows 3.1 or above. **LaserDisc Controller** is available for IBM PC and compatible machines running DOS 3.0 or above, without Windows. All three barcode creation software packages are available through Authorized Pioneer Dealers.

Barcode CD™ is a registered trademark of SONY Corporation.

LaserBarcode™ is a registered trademark of Pioneer Electronic Corporation.

LaserBarcode 2™ is a registered trademark of Pioneer Electronic Corporation.

The LaserBarcode Association strongly recommends that all extended LB2 barcodes include a subscript 2 next to the barcode. Barcode creation software sold by Pioneer follows this recommendation: LB2 extended barcodes have a subscript 2 next to them. These LB2 extended commands must be played on LB2 compatible players. They will not play on LB-only compatible machines such as the discontinued LD-V4200 with a LaserBarcode Adapter/15, the LD-V2000, or on the LD-V2200 player. See **Appendix D, LaserBarcode 2 Commands and Logos**, for sample LB and LB2 barcodes. Notice the subscript 2 next to the LB2 barcodes.

3.3.4 LaserBarcode, LaserBarcode 2 & Barcode CD Logos

Developers and publishers of barcode applications should pay particular attention to the LaserBarcode, LaserBarcode 2 and the Barcode CD command sets and their respective logos. When creating barcode applications that are intended to work with LaserBarcode (LB) compatible machines, developers and publishers must use **only** the original LaserBarcode standard command set. When creating barcode applications to work with LB2 compatible players, developers and publishers can use original LB barcodes as well as LB2 extended commands. Applications for use with CDs on Barcode CD compatible players must use barcodes within the Barcode CD command set. See **Figures I, J and K** below.

NOTE: LaserBarcode standard commands are a sub-set of the LaserBarcode 2 Standard. Applications using only original LaserBarcode standard commands will play on all LB compatible players and on all LB2 compatible players. If, however, an application uses LB2 extended commands (distinguished by the subscript 2 next to the code), the LB2 extended commands will not play on LB compatible players. The symbol in **Figure 3-I** indicates that an application bearing it supports the LaserBarcode standard command set as established by the LaserBarcode Association and can be played on LB or LB2 compatible players. The symbol in **Figure 3-J** indicates applications bearing it contain LaserBarcode 2 **extended commands** and can be played only on LB2 compatible players.

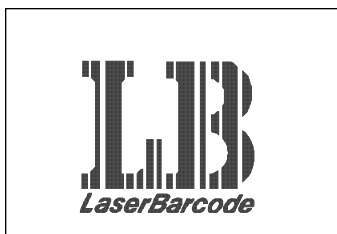

Figure 3-I



Figure 3-J

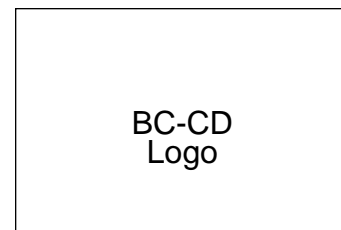

Figure 3-K

CAUTION: LB2 applications that use only the original LB command set may be played on any LB compatible player. LB2 applications that use extended commands can only play on LB2 compatible players. (See **Appendix E**, player compatibility chart. The symbol in **Figure 3-K** indicates that an application bearing it supports the Barcode

CD standard command set and can be played only on Barcode CD compatible players. Customers look for these logos to assure the application can be used with specific players that are LaserBarcode, LB2 or Barcode CD compatible. As mentioned above, LaserBarcode, LB2 or Barcode CD barcodes may be created using Pioneer Barcode preparation software: The **Bar'n'Coder** for the Macintosh[®], or **BarKoder for Windows** or **LaserBarcode Tool Kit** for IBM/MS DOS[®].

NOTE: Contact Pioneer New Media Technologies, Inc., Engineering Support, East — 201/327-6400, or Engineering Support, West — 310/952-2111 for more information on the Barcode System. Contact PNT Marketing, 310/952-2111, for information about licensing the LaserBarcode or LaserBarcode 2 logos.

3.3.5 Pioneer Barcode Readers

All Pioneer Barcode readers, the UC-V108BC, the UC-V109BC, and the discontinued UC-V104BC, can be used to scan and send LB2 “original” and “extended” commands to the LD-V4400. For details about current Pioneer readers, see **Appendix E, Using Pioneer Barcode Readers.**

3.3.6 Barcode Formats and Player Compatibility

All production units of the CLD-V2600, CLD-V2400, LD-V4400 industrial videodisc players are LB2 compatible. LD-V8000 players above serial # ME3912276 are LB2 compatible. An EPROM Upgrade kit is available to provide LB2 compatibility to older LD-V8000 players. LD-V2200 players, discontinued LD-V2000 players, discontinued LD-V4200 players with LBA/15 and the discontinued LD-V6000 players with LBA/25 are LB-Only compatible. The CLD-V2600 and CLD-V2400 are also Barcode CD compatible. See **Player Compatibility Chart** in **Appendix F**. It describes the three barcode formats used for player controls and indicates which formats work with specific players.

3.3.7 Notes

- Check to make sure batteries are fresh in the UC-V108BC or UC-V109BC reader. If using the discontinued UC-V104BC, make sure the batteries are fresh and that the reader's internal switch is set to *Mode 2*.
- Attempting to operate the player via the remote control unit or by using the front panel buttons while sending a barcode command to the player, may result in improper processing of commands. The remote control input and front panel buttons are disabled when the barcode reader is connected via wire to the player.

- On-screen displays are not visible when the barcode reader is used to send barcode commands to control the player. By pressing the Display or Audio button on the remote control unit packaged with the player or on the Autoscanning Barcode Reader, the current disc location or audio settings can be temporarily displayed on the screen. As soon as another barcode is scanned, the display is turned off, unless the Debug On command is sent to the player.
- LaserBarcode standard commands can be sent to either LB or LB2 compatible players. LB2 commands can only be sent to control LB2 compatible players, however, and Barcode CD commands can only be sent to control Barcode CD compatible players.
- If a CD is being played and a LaserBarcode command is scanned and transmitted to the player, the LaserBarcode command is ignored. Conversely, if a LaserDisc is being played and a Barcode CD command is scanned and transmitted to the player, the Barcode CD command is ignored.

4. External Computer Control — Level III

- 4.1 Command and Status**
- 4.2 Error Messages**
- 4.3 Initial Settings**
- 4.4 Level III Commands for LD & CD Control**
- 4.5 Command Formats**
- 4.6 Status Returns**
- 4.7 Level III Command Descriptions**

CHAPTER

4

CLD-V2600

& CLD-V2400

LEVEL I & III

USER'S MANUAL

Programmer's Reference Guide

4 External Computer Control — Level III

This chapter describes the computer control protocol and specific commands used for Level III control of the CLD-V2600 and the CLD-V2400 players. To attach a computer to the player via the RS-232 port, refer to **Appendix C, Interface Cable Specifications**. See **Section 2.4 On-Screen Function Switches**, page 2-13, to select Baud Rate.

4.1 Command and Status

In the CLD-V2600 and the CLD-V2400 external computer control protocol, the computer transmits a command; when the player completes execution of the command, it returns an “R”. ASCII character codes are used for the actual commands and status responses. The command mnemonic is expressed as two ASCII characters. In most cases, there is no distinction between the use of uppercase or lowercase letters, and the use of uppercase letters is recommended.

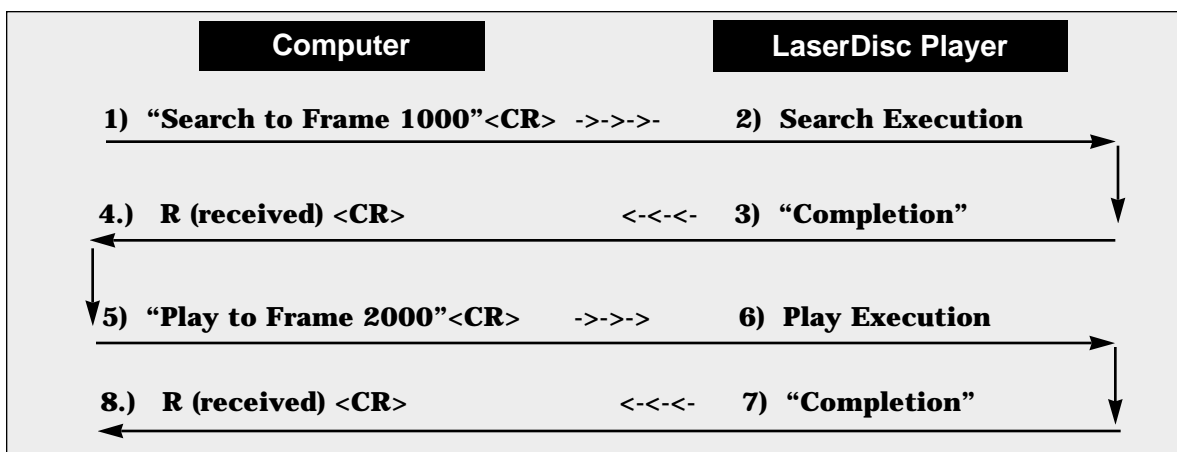

Figure 4-A

Arguments may be set to specify the frame number, speed or other values for a command. The argument is always placed before the command. The command is also used as the terminator of the argument. In the simplest protocol, the player immediately executes one command as soon as the terminator of the command line, a <CR> (carriage return), is received.

Example: 1000SE<CR> : Search to frame 1000.

The player has a command buffer that allows multiple commands to be sent from the external controller in the same command string.

Example: 1000SE 2000PL <CR> : Search to frame 1000, then play to frame 2000.

In this example, when the <CR> is received, commands are executed sequentially from the first command of the buffer. The “R” is returned to the computer after the play segment is completed. If a <CR> is sent before a command or command string has completed execution, the command is cleared and execution is cancelled.

See **Section 4.5**, page 4-7 & 8 for more information about command formats. In the command line, codes such as <SPACE> or <LF> (line feed) that do not affect player operation are ignored. The length of the command line is limited to the buffer size. For the CLD-V2400 and CLD-V2600 the length of a command string is limited to 20 characters. The <CR> or <LF> are not included in the buffer size.

When all the commands in a string are completely executed, the player transmits the “completion” message. (It sends an “R” <CR>.) If an error occurs, an error message such as E04 <CR> is returned by the player. This indicates the error occurrence, along with the error code. See **Sec. 4.2 Error Messages**, page 4-3.

The automatic return of an “R” following command execution is called *Automatic Status*. *Automatic Status* is very useful when working with some computer programs, because it allows the program to know the appropriate time to send the next command. If this function is not used, the command processing time must be taken into consideration before the next command is sent. (To set Automatic Status ON or OFF, see the Level III command for **Communication Control** on page 4-38.)

4.1.1 Request Status

When an error message is received, it may be necessary to determine the player’s current status in order to continue a program. A variety of conditions can occur which may cause an error code to be sent. Since actual hardware failure in the player is a relatively rare event, other conditions may be detected which would allow a program to recover and continue operation. Even when there is no error, there are occasions when player status or disc information is useful. In such a case, the *Request Status* function can be used.

The user may want to find out the current frame number even if there is no error. *Request Status* commands can be useful under these conditions. On the CLD-V2600 and CLD-V2400 players, some of the main *Request Status* commands in Level III are as follows:

- 1) To know the active mode of the player: ?P
- 2) To know the current frame, time, or chapter number for LDs: ?F, ?T, ?C
- 3) To know the current track, time, block index or p-block numbers for CDs: ?R ?T ?B, ?I or ?A

NOTE: These and additional *Request* commands are described in **Section 4.7.4** on page 4-31 through **Section 4.7.7** on page 4-46.

The status functions are summarized in **Figure 4-B** on the next page:

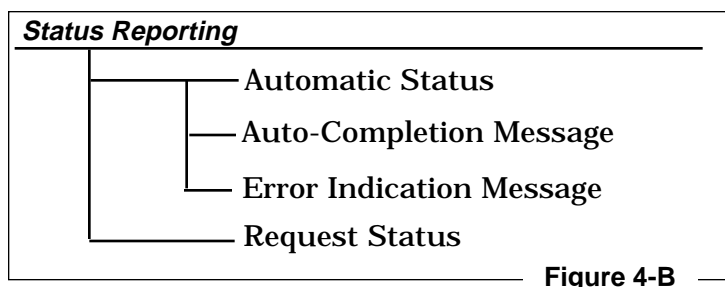

Figure 4-B

4.2 Error Messages

Code	Message	Meaning
E00	Communication error	Communication line error, framing error, buffer overflow error.
E04	Feature not available	Non-usable function has been tried. The command mnemonic is wrong. A command specific to CAV or CLV is sent while the wrong type of disc is in the drawer. Standard User Code is not found on the disc.
E06	Missing argument	Necessary parameter is not specified.
E11	Disc is not loaded	There is no disc in the disc tray.
E12	Search error	Search address cannot be found.
E13	De-focusing error	Laser error: Unfocused
E15	Picture stop	Playing has been stopped by a picture stop code.
E16	Other device Input	The command(s) sent via the serial line were not executed before commands were sent from the front panel keys, and/or the RCU.
E99	Panic	Unrecoverable error occurred. Disc cannot be loaded. Playing cannot be continued.

Figure 4-C

4.3 Initial Settings

The internal registers and switches are set to the following conditions when power is turned on. The settings are not re-initialized when the player is put into *Park* or *Door Open Mode*. Do not forget to set them to the parameters needed when creating an application program. Some of the switch settings can be set only via Register Commands under computer control; others can be set by using the DIP Switches on the rear panel of the player or via Registers. For more information see **Section 4.7.6 Register Control Commands**, page 4-39, and **Section 2.4 Function Switch Settings**, page 2-13.

Register/Switch	Initial Setting	Status
Key lock	0	Unlocked
Video switch	1	ON
Audio switch	7	Digital Stereo (If digital audio is encoded on the disc.)
Display switch	0	OFF
Address flag	3	Frame - CAV; Time - CLV Track - CD, CDV
Speed parameter	60	Normal (X1) speed
Communication Control	Mode 3	Automatic Status
REG. A	3	Frame/Chapter - LD; Track/Time - CD, CDV
REG. B	0	Normal squelch
REG. C	1	Side Repeat ON and Blue Squelch. (Load Start, Power On Start and BAUD Rate can be set using SW 1 & 2 on the players' back panel. Squelch color of Blue or Black can be selected with SW 3 on the back of the CLD-V2600). These options can also be set through Register C under Level III control.

Figure 4-D

4.4 Level III Commands for LD & CD Control

The following commands are available in Level III with the CLD-V2600 and the CLD-V2400 players. Check marks indicate whether the command functions during LD or CD playback. The page number refers to the page that contains a detailed description and examples of how to use the specific command. **NOTE:** An address or argument contained in parentheses can be omitted.

	Command	Mnemonic	Page	LD	CD
1	Door Open	OP	4-11	✓	✓
2	Door Close	CO	4-11	✓	✓
3	Reject	RJ	4-12	✓	✓
4	Start	SA	4-12	✓	✓
5	Play	(Address) PL	4-13	✓	✓
6	Pause	PA	4-14	✓	✓
7	Still	ST	4-14	CAV	
8	Step Forward	SF	4-15	CAV	
9	Step Reverse	SR	4-15	CAV	
10	Scan Forward	NF	4-15	✓	✓
11	Scan Reverse	NR	4-15	✓	✓
12	Multi-Speed Forward	(Address) MF	4-16	CAV	
13	Multi-Speed Reverse	(Address) MR	4-16	CAV	
14	Speed Set	Integer SP	4-17	CAV	
15	Search	Address SE	4-18	✓	✓
16	Stop Marker	Address SM	4-20	✓	✓
17	Frame Set	FR	4-21	✓	
18	Chapter Set	CH	4-21	✓	
19	Time Set	TM	4-22	CLV	✓
20	Track Set	TR	4-22		✓
21	Index Set	IX	4-23		✓
22	Block Set	BK	4-23		✓
23	Clear	CL	4-24	✓	✓
24	Lead-Out	LO	4-24	✓	✓
25	Audio Control	Integer AD	4-25	✓	✓
26	Video Control	Integer VD	4-25	✓	✓
27	Key Lock	Integer KL	4-27	✓	✓

Figure 4-E

List of commands continued on next page

List of Level III Commands for the CLD-V2600 & CLD-V2400 (continued)

	Command	Mnemonic	Page	LD	CD
28	Display Control	Integer DS	4-28	✓	✓
29	Clear Screen	CS	4-29	✓	✓
*30	Print Character	Integer PR	4-30	✓	✓
31	Frame Number Request	?F	4-31	✓	
32	Chapter Number Request	?C	4-31	✓	
33	Time Number Request	?T	4-32	CLV	✓
34	Track Number Request	?R	4-32		✓
35	Index Number Request	?I	4-33		✓
36	Block Number Request	?B	4-33		✓
37	P-Block Number Request	?A	4-33		✓
38	TOC Information Request	?Q	4-34		✓
39	Player Active Mode Request	?P	4-35	✓	✓
40	Disc Status Request (LD)	?D	4-36	✓	
41	Disc Status Request (CD)	?K	4-36		✓
*42	LVP Model Name Request	?X	4-37	✓	✓
43	Communication Control	Integer CM	4-38	✓	✓
44	CCR Mode Request	?M	4-38	✓	✓
45	Register A Set (Display)	Integer RA	4-39	✓	✓
46	Register B Set (Squelch Control)	Integer RB	4-42	✓	✓
47	Register C Set (Miscellaneous)	Integer RC	4-43	✓	✓
48	Register A Request (Display)	\$A	4-44	✓	✓
49	Register B Request (Squelch Control)	\$B	4-44	✓	✓
50	Register C Request (Miscellaneous)	\$C	4-45	✓	✓
51	Input Unit Request	#I	4-46	✓	✓
52	Input Number Wait	?N	4-46	✓	✓

Figure 4-E (continued from previous page)

See **Appendix A** for Alphabetical Listing of all Level III commands available on the CLD-V2600 and CLD-V2400 players; also included is a separate list of LD-commands available and a separate list of CD-commands available. **NOTE:** The * by the command number indicates this command is implemented slightly differently on the CLD-V2600 and CLD-V2400 players. See the command descriptions for details.

4.5 Command Formats

Level III commands on the CLD-V2600 and the CLD-V2400 are expressed as “Command Mnemonics”, so they are easy to remember. “Command Mnemonics” are also used for Level III control of the LD-V2200, LD-V8000, LD-V4400, the LD-V4200 (a discontinued model), the LC-V330 Autochanger, as well as for the LD-V4100 (PAL player), CLD-V2300 (NTSC/PAL) and the LD-V4300D (NTSC/PAL player). Some commands are preceded by an “argument” that is expressed as an integer. These may indicate a specific “address” location on the disc or set function parameters.

Command Mnemonic — Each Level III command is expressed as two ASCII alphabetic characters, representing the command mnemonic. There is no distinction between uppercase letters and lowercase letters. **Example:** PL (Play); Pl (Play); pl (Play).

Argument — An argument is expressed in ASCII digits and it is placed before the command. When a command requiring an argument has no argument, an error (E06) is returned. An argument consists of either an address or an integer:

1) An Address — The address can be a frame number, time number, chapter number (LDs) or time, block, track or index number (CDs) depending how the address flag is set. When an address larger than the maximum allowable value is input, correct evaluation cannot be made. Addresses may be expressed as numbers indicated below:

LDs	Frame number xxxxx	CAV: N1 N2 N3 N4 N5 minimum = 0 0 0 0 0 » maximum = 65535
	Chapter number xx	CAV, CLV N1 N2 minimum = 00 » maximum = 79
	Time numbers H:MM:SS Extended Time numbers H:MM:SS.FF	CLV: N1 N2 N3 N4 N5 (N1=hour, N2 N3=minutes, N4 N5=seconds) minimum = 00000 » maximum = 95959 CLV: N1 N2 N3 N4 N5 N6 N7 (N1=hour, N2 N3=minutes, N4 N5=seconds, N6 N7 Frame No.) minimum = 00000 » maximum = 9595929
CDs	Time N1 N2 N3 N4 MM:SS Block numbers N1 N2 N3 N4 N5 N6 MM:SS:BB	CD N1 N2 N3 N4 N5 N6 N1 N2=minutes, N3 N4=seconds, N5=blocks Minutes 00-99, Seconds 00-59, Blocks 00-74 minimum = 00000 » maximum = 995974
	Track numbers xx	CD N1 N2 minimum = 01 » maximum = 99
	Index numbers xx-xx	CD N1 N2 N3 N4 N1 N2 = Track, N3 N4= Index Track = 01-99, Index = 01-99 minimum = 0101 » maximum = 9999
	Figure 4-F	

2) Integer — This indicates that the argument should be an integer number. The value is used to set a control register to some specified value or condition.

N1 N2 N3 N4 N5
minimum = 00000 » maximum = 65535

NOTE: The maximum value used to set a control register is 255. For details see **Section 4.7.6 Register Control Commands**, page 4-39.

A Search command can accept up to the last frame, chapter or time number encoded on a LaserDisc. Maximum number of frames on one side of a LaserVision standard videodisc is 54,000 (CAV), Chapters, 0-79 (CAV or CLV), time numbers 59.59 (CLV). (One side of CLV disc holds one-hour of full motion video, time numbers can be encoded that describe *running time* of a program taking up several sides of several discs up to 9:59.59.) If a frame, chapter or time number larger than the last one encoded on a LaserDisc is entered, the player will search to the highest number encoded on the disc and then enter *Still* (CAV) or *Pause Mode* (CLV). If a block, index or time number larger than the last one encoded on a CD is entered, the player will not execute the search.

3) (Address) or (Integer) — When an argument, an address or an integer, is indicated in parentheses, it is optional and can be omitted.

Command String — A command string consists of multiple commands. The maximum length of a command string is 20 characters and it is terminated by the <C/R> code (0D hex). **Example:** FR2000SE 2300PL <C/R>

- After the termination, the command string is evaluated, and executed sequentially from the first command.
- The <L/F> code (0A hex) and <SPACE> code (20 hex), even if contained in the command string, will be ignored because <L/F>, <C/R> and <SPACE> are not included in the number of characters which can be transmitted in the command string.
- When an error occurs, subsequent commands in a string will not be executed.
- If a new command string is input before execution of a current string has been completed, the remaining commands are cleared and execution is cancelled. Thus, in order to cancel a currently executing string, simply send the <C/R> without a preceding command. This does not cancel PA, SE, or RJ.
- When the player is put into *Spin-Up*, *Spin-Down* or *Search Mode*, by external commands SA, RJ, or SE, subsequent commands issued will be executed and an “R” will be returned *after* the *Spin-Up*, *Spin-Down* or *Search Mode* cycle is finished, due to the player’s communication protocol. To check the player’s status, send a command to request status, ?P, ?D, ?T, ?R etc. To set player address flags send CH, FR, TM, BL, IX. *If these commands are sent while the mode cycles are in progress, the player will process the command, but won’t send a completion status.*

4.6 Status Returns

The player can return codes to the computer indicating certain status conditions:

1) *Completion Message*

The completion message used in Automatic Status is “R”.

R <C/R>

2) *Error Message*

The error message is indicated by the letter “E” followed by a two-character error number.

E N1 N2 <C/R>

The error message occurs when the given command is non-executable and hinders continued control. A list of the error messages appears in **Section 4.2 Error Messages**, page 4-3

3) *Request Status Return*

- In response to a single request command, the status is displayed as the appropriate character string with a termination code at the end. A termination code of either <C/R> or <C/R> <L/F> can be selected by using Register C.
- If multiple request commands are sent to the player within the same command string, each status value is returned as the appropriate character string with a <C/R> (or <C/R> <L/F>) termination code.

?C?F<C/R> 02 <C/R> 10260 <C/R>

- When the request command is at the end of the command string, “R” of the completion message is omitted.

ST?F <C/R> 23005 <C/R>
 ?FST <C/R> 23005 <C/R> R <C/R>

4) Timing

The timing from the receipt of a command to the return of the status value is as follows:

- T1 is the time from the receipt of <C/R> at the end of the command string to the start of command execution, and is within a maximum of 20 ms.
- T2 is the command execution time, and is at least 14 ms.
T2 (before the <C/R>) increases depending on the type of command.
- The minimum processing time for any command (total of T1 and T2) is 14 ms.

Timing Diagram

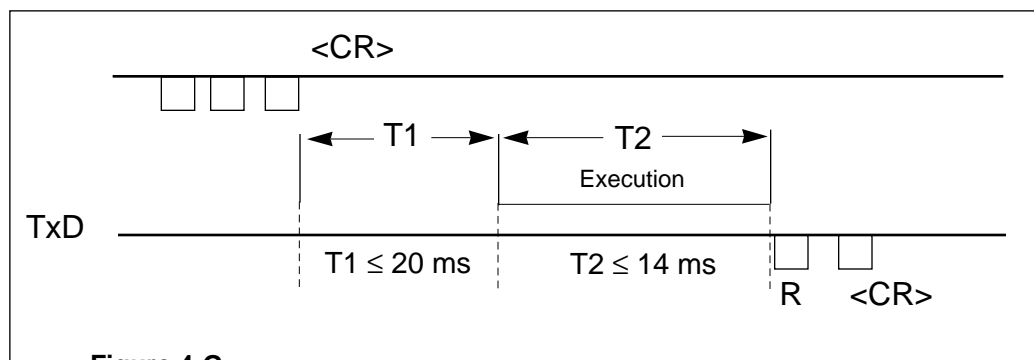

4.7 Level III Command Descriptions

This section of the manual contains a detailed explanation of each Level III command available for use when controlling the CLD-V2600 or CLD-V2400 from an external computer or controller. The format used to describe each command is as follows:

- Title:** The command name with a notation indicating whether the command applies to a LaserDisc, Compact Disc or both.
- Function:** A description of what the command does.
- Format:** The command mnemonic used to send the command to the player.
- Explanation:** A description of how the command is executed.
- Execution:** An example of how to execute the command.

4.7.1 Player Control Commands

1) DOOR OPEN LD/CD

Function: Door is opened.

Format: O P

Explanation: The *Door Open Mode* is the state where the disc tray is opened to change the disc, or the tray is drawn out.

If this command is sent when the player is in *Park*, the door is opened and the *Door Open Mode* starts. This command is also effective in other modes; disc rotation stops and then the door is opened. An error, E04, is returned if the door is already opened.

Execution: * Park Mode
O P <C/R> R <C/R>
* Door Open Mode

2) DOOR CLOSE LD/CD

Function: Door is closed.

Format: C O

Explanation: When the player door is open and this command is received, the player closes the door and enters *Park*. The completion status is returned just after the door has closed. If this command is sent when the player is in some mode other than *Door Open*, or if the door is already closed, an error message, E04, will be returned.

Execution: * Door Open Mode
C O <C/R> R <C/R>
* Park Mode

3) REJECT LD/CD

Function: Disc rotation is stopped.

Format: R J

Explanation: If this command is sent when the player is in *Random Access Mode* or *Setup Mode*, the *Reject Mode* starts and disc rotation stops. When disc rotation completely stops, the completion status is returned, and the player enters *Park*.

Execution: * Random Access Mode
 R J <C/R> R <C/R>
 * Park Mode

4) START LD/CD

Function: Disc rotation is started.

Format: S A

Explanation: If this command is sent when the player is in *Park* or *Reject Mode*, the *Setup Mode* begins and disc rotation is started. When the player is ready to begin playing the audio and video content of the disc, it enters *Pause Mode* at the first position in the program area of the disc. Then the completion status is returned.

Execution: * Park Mode, disc in tray.
 S A <C/R> R <C/R>
 * Pause Mode: Disc is successfully loaded.
 or
 * Park Mode, no disc in tray.
 S A <C/R> E 11 <C/R>
 * Park Mode: There is no disc in the disc tray.

5) PLAY LD/CD

Function: Pictures and sound are reproduced.

Format: (Address) P L

Explanation: 1) If this command is sent when the player is in *Random Access Mode*, video and audio are played at normal speed. *Play Mode* is the only mode in which sound is automatically reproduced with video on LaserDiscs.

2) If an address is specified, the player will play to that address and stop automatically. The specified address is written in the Mark Frame/Time/Block, or Mark Chapter/Track Register and compared with the current address. When both values are equal, *Still Mode* (CAV) or *Pause Mode* (CLV, CDs) occurs; then the completion status is returned. Command completion also occurs when lead-out is found before the specified address is reached.

IMPORTANT NOTE

When using the PLAY command with an address, the auto stop function will be released if any other command, including a status request, is sent to the player before the specified address is reached.

Use the Stop Marker command to achieve an auto stop PLAY function that will allow for status requests and maintain the end address marker.

3) If this command is sent when the player is in *Park* or *Spin-Up Mode*, it is executed and the disc plays from the beginning of the program area. Once playback begins, the completion status is returned. Playback continues until another motion command is received.

Execution #1: * *Park, Spin Up* or *Pause Mode* (CLV or CAV) or *Still Mode* (CAV)
(LDs) P L <C/R> R <C/R>
* *Play Mode*

Execution #2: * *Spin Up, Still* or *Pause Mode* (CAV)
(LDs-CAV) F R 3 2 4 0 0 P L <C/R>
* Plays to Frame 32400 and enters *Still Mode* R <C/R>

Execution #3: * *Spin Up* or *Pause Mode* (CLV)
(LDs- CLV) T M 2 0 2 8 P L <C/R>
* Plays to 20 minutes 28 sec. and enters *Pause Mode* R <C/R>

Execution #4: * *Pause Mode*
(LDs-CLV) F R 2 0 2 8 0 4 P L <CR>
* Plays to 20 min., 28 sec., 4 frames and enters *Pause*. R <C/R>
NOTE: The On-Screen Display will only show 20:28 but if a ?F is issued, the player will return the extended time number: 202804.

Execution #5: * *Pause Mode*
(CDs) T M 0 4 0 4 P L <CR>
* Plays to 04 min. 04 seconds then, enters *Pause Mode*. R <C/R>

Execution #6: * *Pause Mode*
(CDs) B K 0 3 2 8 1 2 P L <CR>
* Plays to 3 min. 28 sec., blk. 12 & enters *Pause Mode*. R <C/R>
NOTE: The On-Screen Display shows 3:28 but if a ?B is sent to the player via computer, the player will return 032812.

6) PAUSE LD/CD

Function: Playback ceases and pausing occurs.

Format: P A

Explanation: If this command is sent to the player while it is in *Random Access Mode*, pausing occurs at the current disc location, video and/or audio playback ceases and a blue (or black) screen appears on the monitor.

Execution: * *Play Mode*
P A <C/R> R <C/R>
* *Pause Mode*
P L <C/R> R <C/R>
* *Play Mode*

7) STILL LD (CAV Only)

Function: Playback is stopped with picture displayed.

Format: S T

Explanation: If this command is sent to the player when it is in *Random Access Mode*, playback stops at that position and *Still Mode* occurs.

Execution: * *Play Mode*
S T <C/R> R <C/R>
* *Still Mode*
P L <C/R> R <C/R>
* *Play Mode*

8) STEP FORWARD LD (CAV Only)

9) STEP REVERSE LD (CAV Only)

Function: Pictures are moved one frame forward or reverse.

Format: S F - STEP FORWARD

 S R - STEP REVERSE

Explanation: If this command is sent to the player when it is in *Random Access Mode*, the pictures will move one frame forward or reverse, and then *Still Mode* occurs.

Execution: * Play Mode

 S F <C/R> R <C/R>

 * Still Mode

 S R S R S R <C/R> R <C/R>

 * Still Mode

10) SCAN FORWARD LD/CD

11) SCAN REVERSE LD/CD

Function: Rapid forward or reverse scanning of the disc.

Format: N F - SCAN FORWARD

 N R - SCAN REVERSE

Explanation: If this command is sent to the player when it is in the *Random Access Mode*, the pictures on a LaserDisc will move at high speed about 500 frames forward or reverse and audio is squelched. This movement is referred to as *Scan Mode*. On a CD, program material is still audible but is scanned at a high speed. When the *Scan* is completed, the original mode is restored and the completion status is returned.

Execution 1: * Play Mode

 N F <C/R> R <C/R>

 * Play Mode

 N R N R N R <C/R> R <C/R>

 * Play Mode

Execution 2: * Still Mode

 N F <C/R> R <C/R>

 * Still Mode

12) **MULTI-SPEED FORWARD** LD (CAV Only)

13) **MULTI-SPEED REVERSE** LD (CAV Only)

Function: Playing is done at the speed set in the speed register.

Format: (Address) M F - MULTI-SPEED FORWARD

(Address) M R - MULTI-SPEED REVERSE

Explanation: 1) If this command is sent to the player when it is in *Random Access Mode*, the *Multi-Speed Mode* occurs. In *Multi-Speed Mode*, the pictures are reproduced at a speed specified by the Speed Register.

2) If an address is specified, playing is done at the speed specified in the Speed Register. The specified address is written in the Mark Frame Register or Mark Chapter Register and compared with the current address. When both values are the same, *Still Mode* occurs. Then the completion status is returned.

IMPORTANT NOTE

When using the MULTI-SPEED command with an address, the auto stop function will be released if any other command, including a status request, is sent before the specified address is reached.

Use the Stop Marker command to achieve an auto stop MULTI-SPEED function. This will allow for status requests and maintain the end address marker.

Execution #1: * Play Mode
M F <C/R> R <C/R>
* Multi-Speed Mode

Execution #2: * Still Mode
F R 3 4 5 0 0 M F <C/R>
* Multi-Speed Mode
Frame 34500 reached R <C/R>
* Still Mode

Execution #2: * Still Mode
F R 3 4 5 0 0 M F 3 4 5 0 0 SM* ?F <C/R>
* Multi-Speed Mode, returns current frame number
Frame 34500 reached R <C/R>
* Still Mode

***Note:** Without the Stop Marker, the player would return the current frame number, then play past frame 34500.

14) SPEED SET LD (CAV Only)

Function: Speed for Multi-Speed playing is specified.

Format: Integer S P

Explanation: Contents of the Speed Register are rewritten with this command. Immediately, the completion status is returned. The active mode of the player does not change. This command is accepted even when *Multi-Speed Mode* is in effect.

The speed parameter indicates the number of fields moved per second, and it is specified in range from 1 to 255. It is 60 (with a range from 45 to 90) for normal play. The initial value is 60.

The relationship between representative play speeds and parameters is as follows:

Integer*	Possible range of integers	Speed	Integer*	Possible range of integers	Speed
180	150-255	X3	15	12-22	1/4
120	91-149	X2	7	6-11	1/8
60	46-90	X1	4	3-5	1/16
30	23-45	1/2	2	0-2	Step 1**

Figure 4-H

* These integers provide compatibility with LD-V8000, LD-V4400 and the LD-V2200. Programs written for the LD-V8000 or LD-V4400 using the “range of integers” in column two will play on the CLD-V2600 and the CLD-V2400 at the corresponding speeds in column three.

Execution: * Play Mode
 3 0 S P M F <C/R> R <C/R>
 * 1/2 speed Multi-Speed play
 15 S P <C/R> R <C/R>
 * 1/4 speed Multi-Speed play

** **NOTE:** 2SP plays one frame every second (Step 1) on the CLD-V2400. Similarly, 2SP sets a Step 1 to play one frame every second on the Pioneer LD-V2200, LD-V4400 and LD-V8000. Early versions of the CLD-V2400 played 1 frame every three seconds (Step 3) if a 0SP or 1SP were sent to the player. Later production units of the CLD-V2400, however, all play Step 1 if a 0SP, 1SP or 2SP is sent to the player. To achieve compatibility across the player line for a one frame per second playback speed, programs should send the 2 SP command, followed by MF (Multi-Speed Forward).

15) SEARCH LD/CD

Function: Search to disc location specified by the address value.

Format: Address S E

Explanation: The specified address is written in the Search Register as indicated by the address flag. When the search is started, the Search Register address is compared with the current address and the pickup is moved so that the difference becomes 0. If a frame address greater than the number of frames on a CAV LaserDisc is specified, the player will search to the last frame number encoded on the disc. The same is true for time numbers on CLV discs. If the address cannot be found, an error message is returned.

On a CD, if an instruction is sent to search to a time, track, index or block address greater than the time, track, index or block numbers encoded on the disc the player will return an error message (E04).

When the specified address is reached on a CAV LaserDisc, *Still Mode* occurs. When the specified address is reached on a CLV LaserDisc or on a CD, *Pause Mode* occurs.

Execution/LDs:

- * **CAV disc in Play Mode** **FR sets address flag to Frame No.**
 F R 4 5 0 0 S E <C/R> R <C/R>
 * Searches to Frame 4500, enters *Still Mode*
- * **CAV disc in Play Mode** **CH sets address flag to Chapter**
 C H 5 S E <C/R> R <C/R>
 * Searches to Chapter 5 and enters *Still Mode*
 6 S E <C/R> R <C/R> (Maintains *Chapter Mode*,
 Searches to beginning of Chapter 6)
- * **CLV disc in Play Mode** **TM sets address flag to Time**
 T M 5 6 3 4 S E <CR> R <CR>
 * Searches to 0 hours, 56 minutes, 34 seconds, enters *Pause Mode*
- * **CLV disc in Play Mode** **CH sets address flag to Chapter**
 C H 5 S E <C/R> R <C/R>
 * Searches to Chapter 5, and enters *Pause Mode*
 6 S E <C/R> R <C/R> (Maintains *Chapter Mode*.)
- * **CLV disc in Play Mode** **FR sets address flag to Frame Value**
 F R 2 6 2 0 1 2 S E <C/R> R <C/R>
 * Searches to 26 min. 20 sec. 12 frames and enters *Pause Mode*

NOTE: This last example will display 26:20 if the On-Screen Display is turned on, but if a ?F <CR> is sent to the player via computer, the player will return 262012.

NOTE: Users should note that searching to the index and block levels on a CD is possible with Level III computer control. These searches are not possible with the remote control unit.

Execution/CDs: * **CD in Play or Pause Mode TM sets address flag to Time**

T M 1212 S E <CR> R <CR>

* Searches to 12 minutes, 12 seconds and enters *Pause Mode*

BK sets address flag to Block

BK 030303 S E <CR> R <CR>

* Searches to 03 minutes, 03 seconds, Block 03, enters *Pause Mode*

NOTE: The command ?B returns 030303. On a CD, track and elapsed time or track-index and time within the track can be displayed by using the remote control unit. Determining the current block number, however, must be done from Level III control using the ?B command. For details see **Section 2-5, On-Screen Displays in Manual Mode** and **Section 4.7.4, Request Commands: #36, Block No. Request** on page 4-33.

TR sets address flag to Track

T R 03 S E <CR> R <CR>

* Searches to track 03 and enters *Pause Mode*.

IX sets address flag to Index

I X 03 01 S E <CR> R <CR>

* Searches to Track 03, Index 01 and enters *Pause Mode*.

NOTE: If only one index is encoded on a CD track, and an instruction is sent to the player to search to index 3, (IX0303SE) the player will search to the beginning of the next track. (In this case, it will search to the beginning of Track 4.)

The range of address entries possible on CDs are described on page 4-7 and again in the reference chart below.

Address Flag	Range of Address
Time:	Minutes 00-99, Seconds 00-59*
Block:	Minutes 00-99, Seconds 00-59, Blocks 00-74
Tracks:	01-99
Index	Track 01-99 Index 01-99
* 74 minutes is the maximum playing time on a CD.	

Figure 4-I

16) STOP MARKER LD/CD

Function: Stop marker is set to the specified address.

Format: Address S M

Explanation: The specified address is written in the Mark Frame/Time/Block Register or Mark Chapter/Track Register as indicated by the address flag, and the completion status “R” is returned immediately. When the stop marker address is reached in *Play* or *Multi-Speed Mode* with a CAV Disc, *Still Mode* occurs. When the stop marker address is reached in *Play* with a CLV disc *Pause Mode* occurs. In both cases, when the stop marker address is reached, the stop marker is cleared from the mark register. The stop marker is also cleared when a step command is issued to step through the address marker on a CAV disc.

Here, the completion status “R” is returned when the command is received and the stop marker is set, not when the address marker is reached, as described in the Play command. Issue a disc location request command (?F,?C,?T,?R etc.) to determine whether not the stop marker address has been reached. If a Clear or Reject command is sent before the stop marker is reached, the stop marker in the the mark register is cleared.

The stop marker is functionally similar to the auto stop operation of the Play and the Multi-Speed commands. However, the auto stop and the stop marker return a completion status at different times. In an auto stop operation, the completion status is returned when the marked address is reached. In the stop marker operation, the completion status is returned when the stop marker is set. *The stop marker command must be used when status requests are sent to the player before the address marker is reached; it is also useful when the operation mode is changed before the marked address is reached.*

Execution #1: * Still Mode

LD (CAV) F R 3 2 427 S M P L <C/R> R <C/R>

* Plays to time number frame value 3 min. 24 sec. 27 frames, then enters *Still Mode*

Execution #2: F R 2 0 2 8 0 4 S M P L <C/R> R <C/R>

LD (CLV) * Plays to extended frame number 202804, then enters *Pause Mode*.

The On-Screen Display shows 20:28, but ?F returns 202804.

Note: TM can also be used to set the Stop Mark on CLV discs; TM, TR, BK, or IX can be used to set the address flag for a Stop Mark on CDs.

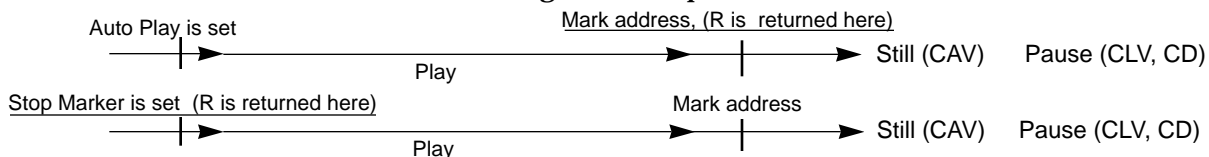

Figure 4-J

17) **FRAME SET** LD

Function: Address flag is set to “frame.”

Format: F R

Explanation: When a CAV LaserDisc is playing, this command sets the address flag to “frame” prior to searches. The player recognizes this address flag until a command indicating a different one is sent. If a CD is playing, this command is unavailable and an error, E04, is returned.

Note: CLV Frame number searches are possible when the address flag is set to Frame and a CLV disc is playing. The player will search to the exact minute, second, and frame number location, then land in Pause. The frame number will not be displayed on screen, but can be verified by issuing the ?F command. See **Appendix J-1, Notes, #5.**

Execution: * CAV Disc, Play Mode
 F R 1 2 4 1 6 S E <C/R> R <C/R>
 * Searches to Frame 12416 on a CAV LaserDisc, and holds a still frame.

* CLV Disc, Play Mode
 F R 1 5 2 3 1 2 S E <C/R> R <C/R>
 * Searches to 15 minutes, 23 seconds, 12 Frames and lands in Pause.
NOTE: 15:23 will appear on the On-Screen Display, but ?F <CR> will return 152312.

18) **CHAPTER SET** LD

Function: Address flag is set to “chapter.”

Format: C H

Explanation: If this command is given, the address flag is set to “chapter,” on a CAV or CLV LaserDisc that is encoded with chapters. The subsequent addresses to be handled are evaluated as chapter numbers. If no chapters are encoded on the disc, or if a CD is playing, an error, E04 is returned.

Execution: * Address flag = frame
 C H <C/R> R <C/R>
 * Address flag = chapter
 1 5 S E <C/R> R <C/R>
 * Search to Chapter 15

19) TIME SET LD (CLV Only) & CD

Function: Address flag is set to "time."

Format: T M

Explanation: If this command is sent when a CLV LaserDisc or a CD is being played, the address flag is set to "time," and the subsequent addresses to be handled are evaluated as time numbers. Time number searches on CLV LaserDiscs includes hours, minutes and seconds up to a maximum number of 95959 (9 hrs. 59 min. 59 sec.). CLV videodiscs contain a maximum capacity of one-hour of playing time on a single side of a disc. Time numbers may be encoded, however, in running succession disc-side to disc-side. If a CAV disc is playing and this command is sent to the player, an error message, E04, will be returned. To access CLV time number frame values, the address flag must be set to Frame. See page 4-21, **#17 Frame Set**.

Time number searches on CDs include minutes and seconds up to a maximum number of 9959 (99 min. 59 sec.). CDs contain a maximum capacity of 74 minutes of playing time on a single side.

Execution#1:* CLV Disc, Play Mode

(LDs) T M 1 2 4 1 6 S E<C/R> R <C/R>

* Search 1 Hr. 24 Min. 16 Sec.

Execution#2:* CD, Play Mode

(CDs) T M 1 2 4 1 S E<C/R> R <C/R>

* Search 12 Min. 41 Sec.

20) TRACK SET CD

Function: Address flag is set to "track."

Format: TR

Explanation: If this command is given, the address flag is set to "track". When a CD is playing, the subsequent addresses to be handled are evaluated as track numbers (01-99). If this command is sent while a LaserDisc is playing, an error message, E04, will be returned.

Execution: * Address flag = Time, a CD is playing

TR <C/R> R <C/R>

* Address flag = track

1 5 S E <C/R> R <C/R>

* Search to Track 15

21) INDEX SET CD

Function: Address flag is set to "index."

Format: IX

Explanation: If this command is sent, the address flag is set to "index," when a CD is playing and the subsequent addresses to be handled are evaluated as index numbers of a specific track. Up to 99 tracks (01-99) and 99 indices (01-99) may be encoded on a CD. An index number is entered as a four digit number that includes the track and index number on the disc (0101-9999). The actual index location can be obtained in Level III computer control by sending a query to the player ?I. Index searches are not accessible using the remote control. If this command is sent while a LaserDisc is playing, an error message, E04, is returned.

Execution: * Address flag = block
 I X <C/R> R <C/R>
 * Address flag = index
 1 4 1 5 S E <C/R> R <C/R>
 * Search to track 14, block 15.

22) BLOCK SET CD

Function: Address flag is set to "block."

Format: B K

Explanation: If this command is sent, the address flag is set to "block," when a CD is playing and the subsequent addresses to be handled are evaluated as time numbers which include blocks. A block number is entered as a six digit number that includes the minute, second, and block of the elapsed time on the disc. The maximum number is 995974, 99 minutes, 59 seconds and 74 blocks. The actual block location can be obtained in Level III computer control by sending a query to the player ?B. Block mode is not accessible using the remote control. If this command is sent while a LaserDisc is playing, an error message, E04, is returned.

Execution: * Address flag = track
 B K <C/R> R <C/R>
 * Address flag = block
 1 4 1 5 1 6 S E <C/R> R <C/R>
 * Search to 14 minutes 15 seconds and the 16th block.

23) CLEAR LD/CD

Function: To clear a value entry or a player mode.

Format: C L

Explanation: 1) Contents of the digit buffer (input value) are cleared. Immediately, the completion status is returned.

2) *Search, Auto Stop, Auto Stop Multi-Speed or Stop Marker Mode* are released. If cleared during a search, the clearance is made near the current pickup position, and *Still Mode* occurs if a CAV disc is in the disc tray, or *Pause Mode* occurs if a CLV disc or CD is being used.

If cleared during an auto stop or stop marker operation, normal play occurs. If cleared during auto stop multi-speed operation when a CAV LaserDisc is playing, regular multi-speed play occurs.

Execution: * Play Mode
2 2 0 0 0 C L 2 3 0 0 0 S E <C/R>
* Search mode
C L <C/R> R <C/R>
* Still mode

24) LEAD-OUT LD/CD

Function: Lead-out is set for an address.

Format: L O

Explanation: The lead out symbol can be used in place of a number as the target address of a search or auto-play operation. If the leadout command is sent while an LD is playing, the "LO" value can be estimated as follows:

Frame number	65535 (CAV), 9595929 (CLV)
Time Code	95959 (9 hour 59 minutes 59 seconds)
Chapter number	79

When a lead-out search is made on the CLD-V2400, the convergence occurs immediately before the lead-out area, i.e. at the end of the program area. During CD playback, in some cases the actual lead out is longer than the lead out time recorded in the TOC information.

Execution #1: L O S E <C/R> R <C/R>
?F <C/R> 5 0 4 0 0 <C/R>
* The last address of the program area on a LaserDisc is searched and the value is returned in response to ?F.

Execution #2: L O P L <C/R> R <C/R>
* Plays to last chapter, frame or time number before lead-out when the last address is unknown. Set Chapter, Frame or Time Mode first.

4.7.2 Player Control Switch Commands

25) AUDIO CONTROL LD/CD

Function: The audio output condition is selected.

Format: Integer A D

Explanation: The contents of the Audio Control Register are rewritten. The completion status is returned immediately. The relationship between the contents of the register specified by the integer and the output audio channel is indicated in **Figures 4-K** and **4-L** on the next page.

Execution: 3 A D <CR> R <CR>
* Play stereo analog tracks only

Arg.	Setting	Arg.	Setting
0	OFF	4	OFF
1	ANALOG CH 1	5	DIGITAL CH 1
2	ANALOG CH 2	6	DIGITAL CH 2
3	ANALOG STEREO	7	DIGITAL STEREO

26) VIDEO CONTROL LD/CD

Function: Video switch is turned ON/OFF.

Format: Integer V D

Explanation: The Video Control Register is reset. The initial value of the register is 1 (the video switch is ON). In this condition, the Video Switch is controlled by the Squelch Switch. When in *Park* or *Search* or *Pause Mode*, the Squelch Switch is OFF and a blue screen appears. (See **Figure 4-M** on page 4-27.)

When the video switch is turned OFF, the screen is squelched at all times. The squelch condition may be set to show a blue screen or a black screen by adjusting the background color selection parameter in Register C.

Integer	Function	Video Switch
0	Off	0
1	On (Normal)	1

Audio Control Register

ARG.	FUNCTION	S0	S1	S2	S3	S4	S5	S6	S7	S8	S9
0	OFF	0	0	0	0	0	0	1	0	1	0
1	ANALOG CH1	1	0	1	1	0	1	1	0	1	0
2	ANALOG CH2	0	1	1	0	1	1	1	0	1	0
3	ANALOG STEREO	1	1	0	1	1	0	1	0	1	0
4	OFF	0	0	0	0	0	0	0	1	0	1
5	DIGITAL CH1	1	0	1	1	0	1	0	1	0	1
6	DIGITAL CH2	0	1	1	0	1	1	0	1	0	1
7	DIGITAL STEREO	1	1	0	1	1	0	0	1	0	1

Figure 4-K

CAUTION: If a disc contains only analog or only digital audio, S6 through S9 are set as indicated:

FUNCTION	S6	S7	S8	S9
Analog Audio Only	1	0	1	0
Digital Audio Only	0	1	0	1

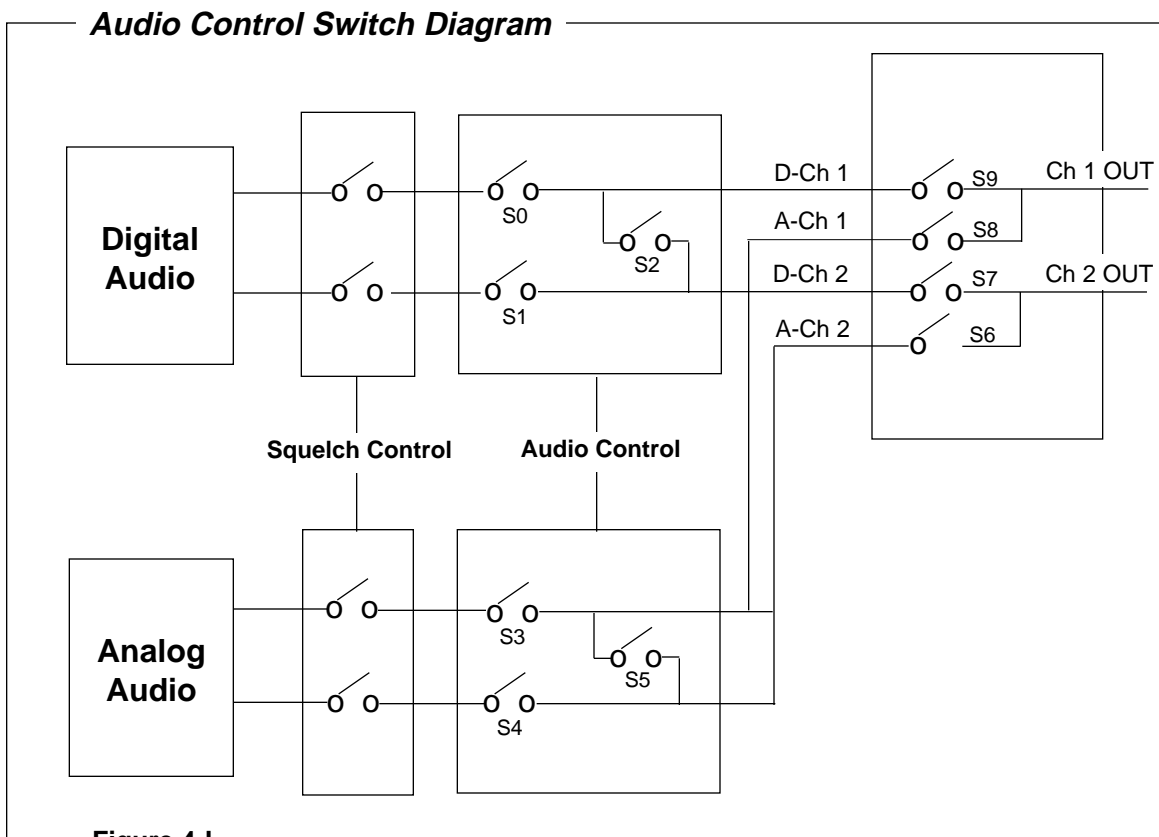

Figure 4-L

Video Control Diagram

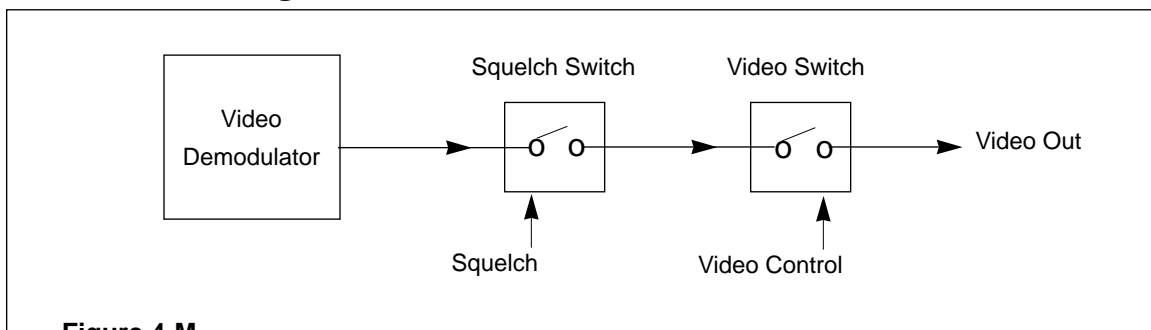

Figure 4-M

Execution: * Video Switch = ON
 0 V D <C/R> R <C/R>
 * Video Switch = OFF

27) KEY LOCK LD/CD

Function: The key lock switch is turned ON/OFF.

Format: Integer K L

Explanation: Operation of the front panel keys and RCU input are locked or unlocked.

The completion status is returned immediately. The initial value of OFF means the Keys on the front panel and RCU are unlocked. A value of 1 means ON, and they are locked. At that time, the key lock LED is set ON and operation of all control keys on the player and the remote control unit are locked out. The power switch can be used.

KEY LOCK SWITCH

Integer	Function
0	Unlock
1	Lock

Execution: 1 K L <C/R> R <C/R>
 * Key Lock ON
 0 K L <C/R> R <C/R>
 * Key Lock OFF

4.7.3 Display Control

28) DISPLAY CONTROL LD/CD

Function: Character display is turned ON/OFF.

Format: Integer D S

Explanation: Contents of the Display Control Register are displayed.

The initial value of the register is 0 and the display switch is OFF. When it is turned on, (1DS) the chapter number, frame number or time number and the user's area can be displayed if an LD is playing and if chapters are encoded on the disc. If a CD is playing track, index, time numbers and the user's area can be displayed. The display lines are determined by the Register A setting. At power-on, the default setting for Register A is 3RA. This makes available the frame or time number on LDs and chapter numbers if they are encoded on the disc. If a CD is playing, track and time are available. The actual items to be displayed are determined by the contents of Register A. See page 4-39 for details about Register A.

Integer	Function	Display Switch
0	Display Off	0
1	Display On	1

Execution: * Display switch = OFF.
 1 D S <C/R> R <C/R>
 * Display switch = ON

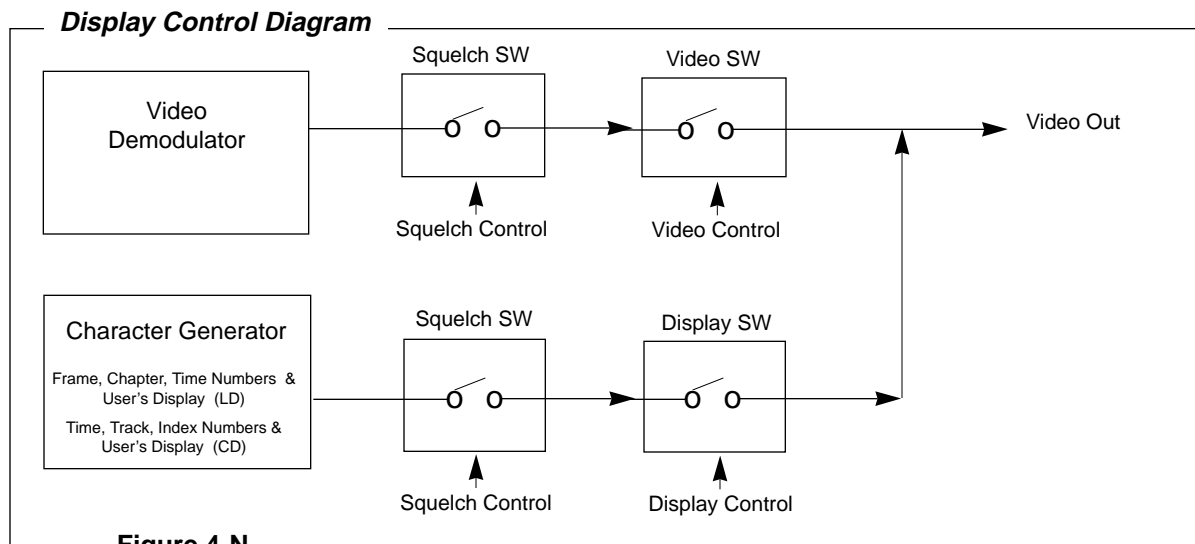

Figure 4-N

29) CLEAR SCREEN LD/CD

Function: The characters shown in the User Display Area are cleared.

Format: C S

Explanation: Characters on all of the lines are cleared. To clear only a particular line, overwrite the line with spaces by means of the PR command.

Execution: C S 3 P R <C/R> R <C/R>
HELLO ! <C/R> R <C/R>
* All the lines are cleared and a string of seven characters is written in Line 3.

4 P R <C/R> R <C/R>
SELECT A MENU ITEM <C/R> R <C/R>
* A string of 18 characters is written in Line 4.

3 P R <C/R> R <C/R>
string of seven spaces <C/R> R <C/R>
* Spaces overwrite the seven character word in line 3, so it appears only line 3 is cleared.

CS<C/R> R<C/R>
* All lines are cleared.

30) PRINT CHARACTER LD/CD

Function: Characters are written into the User's Display Area.

Format: Integer P R <C/R>
 Character string <C/R>

Explanation: The character string for one line in the User Display Area is written with this command. It is effective when the user's display specification of Register A is set to ON (4RA).

First, specify the line number using an integer. (Lines 0-11 are selectable on the CLD-V2600 and lines 0-9 are selectable on the CLD-V2400.) After the command character PR is entered, it is terminated with the <C/R> code. In the next command line, specify the character string. A character string up to 20 characters is allowed. Any commands subsequent to the command character (PR <CR>), but prior to the character string's <C/R>, are interpreted as characters to be printed to the User Display Area.

Usable characters are shown in the **Character Code Table** below.

		Low-order Byte															
		0	1	2	3	4	5	6	7	8	9	A	B	C	D	E	F
High-order Byte	2	!	"	#	\$	%	&	'	()	*	+	,	-	.	/	
	3	0	1	2	3	4	5	6	7	8	9	:	;	<	=	>	?
	4	@	A	B	C	D	E	F	G	H	I	J	K	L	M	N	O
	5	P	Q	R	S	T	U	V	W	X	Y	Z	←	¥	→	■	_
	6	`	a	b	c	d	e	f	g	h	i	j	k	l	m	n	o
	7	p	q	r	s	t	u	v	w	x	y	z	↑		↓		
	8	ç	ü	é	â	ä	à	á	ç	ê	ë	è	ï	î	ì	Ä	Å
	9	É	æ	Æ	ô	ö	ò	û	ù	ÿ	Ö	Ü	ø	£	ß	Pt	f

The character "7F" is not available.

Figure 4-O

Execution: 4 R A 1 D S <C/R> R <C/R>
 4 P R <C/R> R <C/R>
 ***** <C/R> R <C/R>

5 P R <C/R> R <C/R>
 * PROGRAM START * <C/R> R <C/R>

6 P R <C/R> R <C/R>
 ***** <C/R> R <C/R>

4.7.4 Request Commands

31) FRAME NUMBER REQUEST LD

Function: The frame number which is currently being played is returned.

Format: ? F

Explanation: Contents of the current Frame Register are returned.

During playback of a CAV disc, a 5-digit frame number is returned. During playback of a CLV disc, a 6-digit frame number is returned. (See **Appendix J-1, Notes, #5**, for details.) Correct values are not shown if the player is not in *Random Access Mode*, or if the player is in the lead-in or lead-out area of a disc.

As seen in the example, continuous frame numbers may not be received due to timing delays between the computer and the player. If a frame number code on the disc cannot be correctly read, the previous value is used. An error (E04) is returned if this query is sent to the player while a CD is playing.

Execution:	* Play Mode (CAV)		* Play Mode (CLV)
	? F <C/R>	0 2 0 4 4 <C/R>	? F <C/R> 0 10 4 4 2<C/R>
	? F <C/R>	0 2 0 4 5 <C/R>	? F <C/R> 0 10 4 4 6<C/R>
	? F <C/R>	0 2 0 4 5 <C/R>	? F <C/R> 0 10 5 0 2<C/R>
	? F <C/R>	0 2 0 4 7 <C/R>	? F <C/R> 0 10 5 0 7<C/R>

32) CHAPTER NUMBER REQUEST LD

Function: The chapter number which is currently being played is returned.

Format: ? C

Explanation: Contents of the Chapter Number Register are returned.

The chapter number is a 2-digit integer (00-79). Some LaserDiscs are not encoded with chapter numbers. When playing a disc without chapters, an error is returned when this request is issued. Correct values will not be shown if the player is not in *Random Access Mode*, or if the player is in the lead-in or lead-out area of a disc. An error (E04) is returned if this query is sent to the player while a CD is playing.

Execution:	* Play Mode	
	? C <C/R>	1 2 <C/R>

33) TIME NUMBER REQUEST LD (CLV Only) & CD

Function: The time number indicating the current disc address is returned when a CLV LaserDisc or when a CD is played.

Format: ? T

Explanation: Contents of the current Time Register are returned.

When a CLV disc is being played, time numbers are contained in the Frame Register. Time numbers encoded on most discs manufactured since the early 80's consist of extended time numbers: hour, minutes, seconds, and frames. The CLD-V2400 will access the hours, minutes and seconds encoded on the disc. Older discs may only be encoded with hours and minutes. When a disc not encoded with seconds is played, the seconds unit is fixed to 0. To access CLV time number frame values on discs encoded with hours, minutes, seconds and frame numbers, send a ?F to the player. See page **4-31, Frame Set**, also **Appendix J-1, Notes, #5**.

Correct values will not be shown if the player is not in *Random Access Mode*, or if the player is in the lead-in or lead-out area of a disc. If a time number on the disc cannot be correctly read, the previous number is used. When a CD is played, the player returns a four digit number minutes (00-99) and seconds (00-59). A single side of a CD contains a maximum of 74 minutes of playing time.

Execution #1: * Play Mode, CLV LaserDisc playing
(LD's) ? T <C/R> 0 3 2 1 3 <C/R>
(0 hour, 32 minutes, 13 seconds)

Execution #2: * Play Mode, CD playing
(CD's) ? T <C/R> 0 3 2 1 <C/R>
(3 minutes, 21 seconds)

34) TRACK NUMBER REQUEST CD

Function: The track number which is currently being played is returned.

Format: ? R

Explanation: Contents of the Track Number Register are returned.

The track number is a 2-digit integer. Correct values will not be shown if the player is not in *Random Access Mode*, or if the player is in the lead-in or lead-out area of a disc. An error (E04) is returned if this query is sent to the player while a LaserDisc is playing.

Execution: * Play Mode, Track 12 of a CD is playing
? R <C/R> 1 2 <C/R>

35) INDEX NUMBER REQUEST CD

Function: The index number which is currently being played is returned.

Format: ? I

Explanation: Contents of the Index Number Register are returned.

The index number is returned with the track number as a 4-digit integer: track number (01-99) and index number (01-99). Correct values will not be shown if the player is not in *Random Access Mode*, or if the player is in the lead-in or lead-out area of a disc. An error (E04) is returned if this query is sent to the player while a LaserDisc is playing.

Execution: * Play Mode, Track 12, Index 03 of a CD is playing
? I <C/R> 1203 <C/R>

36) BLOCK NUMBER REQUEST CD

Function: The block number which is currently being played is returned.

Format: ? B

Explanation: Contents of the Block Number Register are returned.

The block number is returned as part of a 6-digit integer: minutes (00-59), seconds (00-59) and block number (00-74). Correct values will not be shown if the player is not in *Random Access Mode*, or if the player is in the lead-in or lead-out area of a disc. An error (E04) is returned if this query is sent to the player while a LaserDisc is playing. Block locations are not available through the on-screen display.

Execution: * Play Mode plays to 12 minutes, 05 seconds, block 15 of a CD.
? B <C/R> 120515 <C/R>

37) P-BLOCK NUMBER REQUEST CD

Function: The current track, index and P-time (elapsed time of current track) numbers are returned.

Format: ? A

Explanation: Contents of the P-Time Number Register are returned.

The current track, index and P-time (elapsed time of current track) are returned together as a 10-digit integer. If this command is used when playing the disc at normal speed, the block numbers are renewed even while communication is taking place. As shown in the example below, continuous block numbers may not be received.

Correct values will not be shown if the player is not in *Random Access Mode*, or when playback is in the lead-in or lead out area of the disc. If a block number code of the disc cannot be correctly read, the previous value is retained.

Execution: * Play Mode
 ? A <C/R> 0401022546 <C/R>
 * Track 4, Index 1, 2 minutes, 25 seconds, 46 blocks
 ? A <C/R> 0401022547 <C/R>
 * Track 4, Index 1, 2 minutes, 25 seconds, 47 blocks
 ? A <C/R> 0401022550 <C/R>
 * Track 4, Index 1, 2 minutes, 25 seconds, 50 blocks
 ? A <C/R> 0401022552 <C/R>
 * Track 4, Index 1, 2 minutes, 25 seconds, 52 blocks

38) TOC INFORMATION CD

Function: TOC information is returned.

Format: ? Q

Explanation: This command returns a 10-digit integer that includes: The track number of the first track, the track number of the last track and the absolute time before lead-out in the following format. See example below:

C1 C2 C3 C4 C5 C6 C7 C8 C9 C10

C1 C2 : Track number of the first track

C3 C4 : Track number of the last track

C5 C6 C7 C8 C9 C10 : absolute time before lead-out.

Execution: * Play Mode
 ? Q <C/R> 0112253540 <C/R>
 * First track =01;
 Last track = 12;
 Absolute time before lead-out =
 25 minutes, 35 seconds, 40 blocks

39) PLAYER ACTIVE MODE REQUEST LD/CD

Function: The value representing the current active mode of the player is returned.

Format: ? P

Explanation: Active modes are returned according to the classification shown in the following table. This command is useful in confirming whether the player has already been started and placed in *Random Access Mode*.

<i>Player Active Mode Request Codes</i>			
Code	Player Mode	Code	Player Mode
P00	Door Open	P05	Still
P01	Park	P06	Pause
P02	Set Up	P07	Search
P03	Disc Unloading	P08	Scan
P04	Play	P09	Multi-Speed

Figure 4-P

- P00 (Door Open): Door is open, disc tray is out.
- P01 (Park): Disc rotation is stopped or disc tray is closing or disc tray is closed and no disc is loaded
- P02 (Set Up): Preparing to play
- P03 (Disc Unloading): Disc tray is opening
- P04 (Play): Images and sound are reproduced at normal speed
- P05 (Still): Picture is displayed as a still
- P06 (Pause): Pausing occurs without picture display
- P07 (Search): Searching for a specific address
- P08 (Scan): Scanning; high speed playback in forward or reverse
- P09 (Multi-Speed): Playing in Multi-Speed

Execution:

- * Play Mode
- ? P <C/R> P 0 4 <C/R>
- S T <C/R> R <C/R>
- * Still Mode
- ? P <C/R> P 0 5 <C/R>

40) DISC STATUS REQUEST LD

Function: Attributes of the disc being played are returned.

Format: ? D

Explanation: Status information concerning the disc is returned in the following format. If this command is sent while a CD is playing, an error code, E04, is returned.

C1	C2	C3	C4	C5	<C/R>
C1: disc loading	0 = not loaded		1 = loaded		
C2: CAV/CLV	0 = CAV		1 = CLV		X = unknown
C3: disc size	0 = 12 inch		1 = 8 inch		X = unknown
C4: disc side	0 = Side 1		1 = Side 2		X = unknown
C5: chapter code	0 = no		1 = yes		X = unknown

Execution: ? D <C/R> 0 X X X X <C/R>
 * Disc is not loaded.
 ? D <C/R> 1 0 0 0 1 <C/R>
 * The disc loaded is a CAV 12-inch disc, Side 1, with chapters.

41) DISC STATUS REQUEST CD or CDV

Function: Attributes of the disc being played are returned.

Format: ? K

Explanation: Status information concerning the disc is returned in the following format. If this command is sent while a LaserDisc is playing, an error code, E04, will be returned.

C1	C2	C3	C4	C5	C6	C7	C8	<C/R>
C1: disc loading	0 = not loaded			1 = loaded				
C2: Unused	fixed as X = unknown							
C3: Unused	fixed as X = unknown							
C4: CD or CDV	0 = CD			1 = CDV				X = unknown
C5: (Reserved)	fixed as X = unknown							
C6: (Reserved)	fixed as X = unknown							
C7: (Reserved)	fixed as X = unknown							
C8: (Reserved)	fixed as X = unknown							

See Execution on next page:

Execution: ? K <C/R> 0 X X X X X XX <C/R>
 * Disc is not loaded.
 ? D <C/R> 1 X X0X X X X <C/R>
 * A CD is loaded.
 ? D <C/R> E04 <C/R>
 * A LaserDisc is loaded.

42) LVP MODEL NAME REQUEST LD/CD

Function: Player's model name is returned.

Format: ? X

Explanation: The model name of the CLD-V2600 is returned as: P1527XX
 The model name of the CLD-V2400 is returned as: P1518XX

First 3 characters (P15) indicate the player is a Pioneer LaserDisc Player. The next two characters (27 or 18 in the examples above) indicate the player series or model number. The CLD-V2600 will return 27 as the next two digits; the CLD-V2400 will return 18. **The last two digits (XX) represent the player version number and they are updated periodically as running changes are made to the players.**

Execution: ? X <C/R> P 1 5 1 8 0 1 <C/R>
 In this example the last two digits (XX) = 01, which was the first version number of the CLD-V2400.

For more information see **Technical Bulletin #148A, Pioneer Industrial LaserDisc Player Model Numbers.**

NOTE: The CLD-V2600 and the CLD-V2400 players do not support the ?U command allowing access to Standard User's Code that may be encoded on LaserDiscs.

4.7.5 Communication Control Commands

43) COMMUNICATION CONTROL LD/CD

Function: Communication mode is selected.

Format: Integer C M

Explanation: Contents of the communication control register (CCR) are rewritten. For the CLD-V2600 and the CLD-V2400, the Automatic Status can be selected ON or OFF. When Automatic Status is ON the Player returns an "R" upon execution of a command, when it is OFF, it does not.

Integer	Mode	Auto-Status
2	MODE-2	OFF — "R" not returned
3	MODE-3	ON — "R" returned

The initial value (default value) of the CCR is set to Mode 3. With this command, it is possible to change the communication mode as required. If an unsupported mode is specified, an error occurs.

Execution:

- * CCR = 3 Player's set to CCR Mode 3; no "R" is returned
- 2 C M <C/R> (Note: No "R" is returned here, as player is in currently in CCR Mode 3.)
- * CCR = 2 Player is in CCR Mode 2, "R" is returned
- 3 C M <C/R> R <C/R> (Note: "R" is returned, as player is in CCR Mode 2.)
- * CCR = 3 Player is in CCR Mode 3, no "R" returned

44) CCR MODE REQUEST LD/CD

Function: Current communication mode is returned.

CM2	MODE-2
CM3	MODE-3

Format: ? M

Explanation: Contents of the communication control register (CCR) are returned, indicating the current communication mode.

Execution:

- * CCR = 3
- ? M <C/R> CM3 <C/R>

4.7.6 Register Control Commands

45) REGISTER A SET LD/CD

Function: Changes the current setting of Register A. (Display)

Format: Integer R A

Explanation: In Register A, detailed attributes concerning the display are set. The CLD-V2600 & the CLD-V2400 have three types of display settings: Frame number (LD-CAV) or Time number (LD-CLV, CD); Chapter number (LD-CAV or CLV) or Track-Index number (CD); and User's Display for user-generated messages, lines 0-9 on the CLD-V2400 and lines 0-11 on the CLD-V2600. Available combinations of the display settings are shown in the following table. Initial value is 3.

Integer	Function	User's	Chapter/ Track	Frame/ Time
0	Display Off	0	0	0
1	Frame or Time Number	0	0	1
2	Chapter or Track Number	0	1	0
3	Frame or Time and Chapter or Track	0	1	1
4	User's Display	1	0	0
5	User's Display and Frame or Time	1	0	1
6	User's Display and Chapter or Track	1	1	0
7	User's Display and Frame or Time, and Chapter or Track	1	1	1

Figure 4-Q

All the character displays are turned ON/OFF by the display control command. The display contents are determined by Register A.

* CD Track and Index numbers are processed in the Chapter Register. CD Block numbers are processed as part of the time number in the Frame/Time Register.

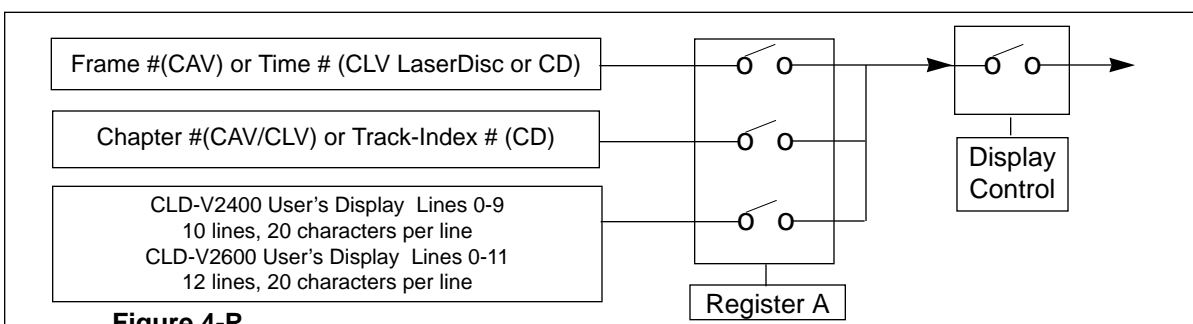

Figure 4-R

The display positions on the screen for the CLD-V2600 are pictured below:

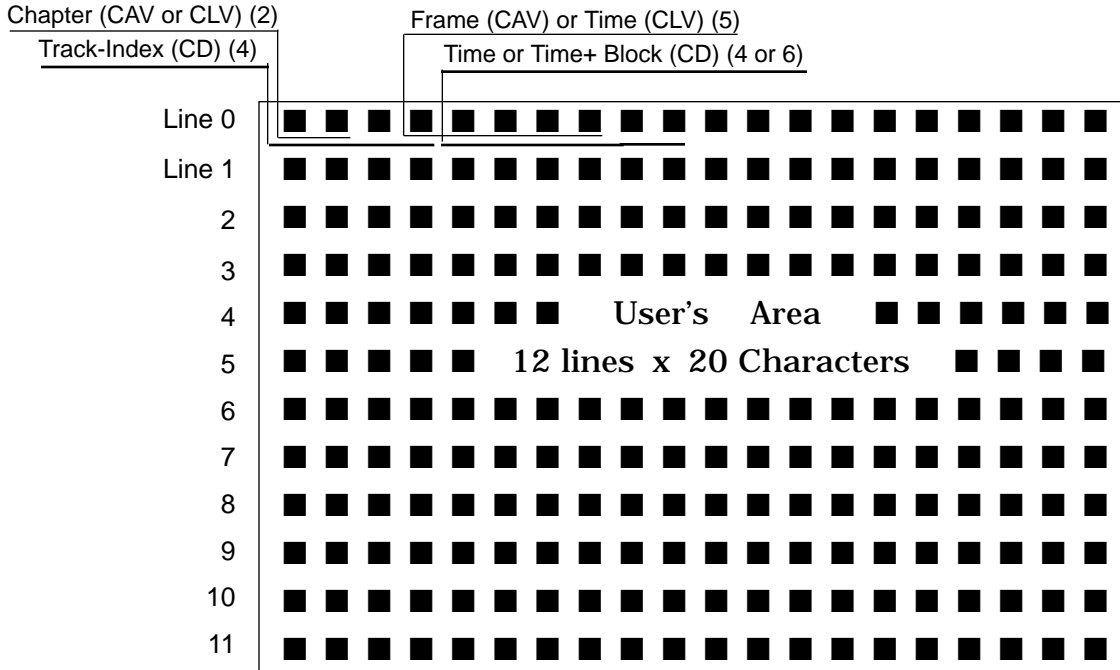

Figure 4-S

The display positions on the screen for the CLD-V2400 are pictured below:

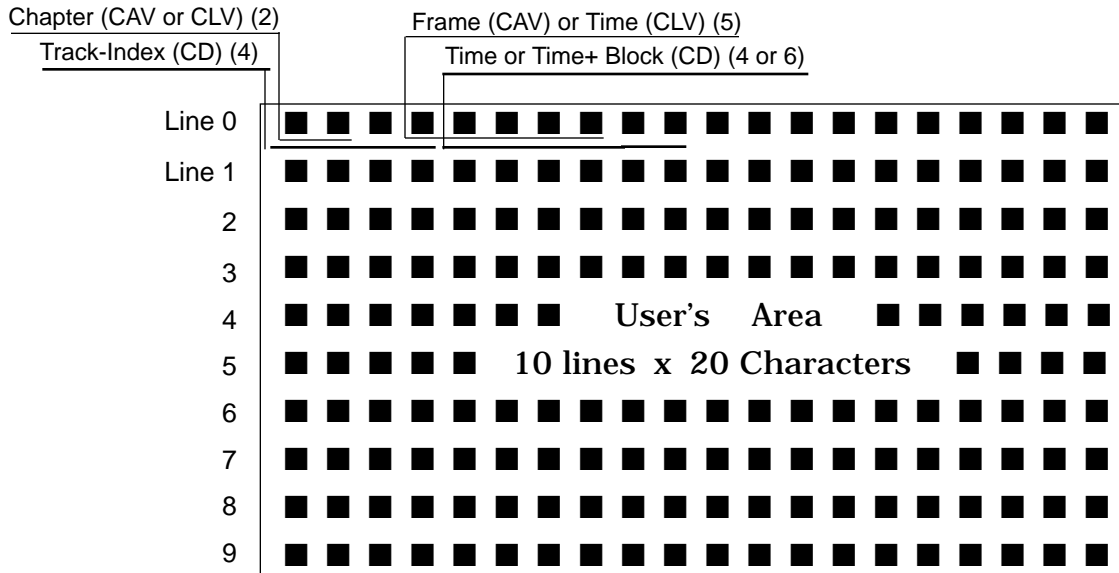

Figure 4-T

Line 0 is used for displaying chapter, frame, time and track numbers.
 Line 0 and 1 are sometimes used for displaying remote control inputs.

Line 2 to 11 are used exclusively as the User's Display Area on the CLD-V2600.

Line 2 to 9 are used exclusively as the User's Display Area on the CLD-V2400.

If all lines of the User's Display Area are required for user defined messages, the 4RA command can be sent to the player. This will reserve all lines (including lines 0 and 1) in the display for user messages. **NOTE:** Lines 0 & 1 are usually reserved for frame/time and chapter/track addresses and the address flag status.

To activate the User Display Area:

- Set the User's Display using the Register A command.
- Turn ON the display switch.
- Identify the line on which the characters will appear by using the Print Character command (PR) <CR>. (See page 4-30.)
- Then send the character string to be displayed followed by <C/R>.

NOTE: The display switch can be turned ON or OFF at any time. However, if Register A is changed so that the User's Display Area is disabled, the contents of the User's Display Area will be cleared. Also, if the Print Character command is issued before Register A is set for the User's Display Area, the character string will not be seen. The Power-On default for display control is 3RA. This allows Frame/Time, Chapter/Track numbers to be seen when the display is turned on, depending on the type of disc that is in the tray. Register A may be changed for different displays. See example below:

Execution: * Display OFF, CAV LaserDisc is in the tray

1DS <C/R> R <C/R>

* Display ON - Frame, Chapter Display

1RA <C/R> R <C/R>

* Only frame number is displayed

4RA <C/R> R <C/R>

* User's Display lines only are displayed

3PR <C/R> R <C/R>

* Print the following string of characters to Line 3 of the display

HELLO WORLD R <C/R>

* The message "HELLO WORLD" is displayed on Line 3 of User's Display Area.

46) REGISTER B SET LD/CD

Function: Changes the current setting of Register B. (Squelch Control)

Format: Integer R B

Explanation: Attributes concerning the squelch switch for video and audio are set in Register B. The squelch switch is normally controlled automatically in accordance with the operating mode of the player.

In the modes where pictures and sound are not clearly reproduced, the squelch switch prevents the noise from being displayed or heard. (eg. During scanning on LaserDiscs, audio is squelched.)

By rewriting the contents of the Register B, it is possible to make the squelch switch invalid. In this state, the video and audio signals are continually output.

The initial value is 0.

It must be noted that these signals may contain noise components which may adversely affect equipment connected to the output of the player. Therefore, the operation must be fully understood before this function is used.

Integer	Function	Video	Audio
0	Normal	0	0
64	Audio Squelch Invalid	0	1
128	Video Squelch Invalid	1	0
192	VD/AD Squelch Invalid	1	1

Figure 4-U

Execution: * Disable the video squelch during searching.
 128 R B 23000 S E 0 R B <C/R> R <C/R>

* Play at 1/2 speed while outputting sound.
 64 R B 30 S P M F <C/R> R <C/R>

* Set to Still and return to normal squelch.
 STORB <C/R> R <C/R>

47) REGISTER C SET LD/CD

Function: Changes the current setting of Register C. (Miscellaneous)

Format: Integer R C

Explanation: When power is turned ON, the Side Repeat function of Register C is set to ON. If Function Switch 1 on the rear panel of the player is ON (DOWN), the Load Start and Power-On Start functions of Register C are also set to ON. If Function Switch 2 is ON (DOWN), the Baud Rate is set to 1200. Note that some functions, such as Test Mode, may suspend playback or disable further control.

The functions listed below can be set. To set a function to ON, give the value indicated by the integer. To set multiple functions to ON, the integer values must be added up. All eight functions can be specified in combination by using the decimal values from 0 to 255. The completion status is returned immediately.

NOTE: When “Repeat Side” or “Chapter Repeat” is selected by the RCU, the Side Repeat function of Register C goes to “ON” and when “Auto Return” is selected by the RCU, the Side Repeat Function of Register C goes to “OFF”.

Integer	Function	1	0
1	Side-Repeat	ON	OFF
2	Load-Start	ON	OFF
4	Power-on-Start	ON	OFF
8	(Not Used)	—	—
16	Background Color	BLACK	BLUE
32	TxD Terminator	<CR+LF>	<CR>
64	BAUD Rate	1200	4800
128	Test Mode	ON	OFF

Figure 4-V

NOTE: Test Mode is used when the player is serviced, to evaluate player operations.

Execution:

- * Initial value 0
- 3 R C <C/R> R <C/R>
- * Side-Repeat, Load-Start to ON, background color BLUE
- 1 6 R C <C/R> R <C/R>
- * Background Color BLACK; Side-Repeat and Load-Start to OFF

48) REGISTER A REQUEST LD/CD

Function: Returns the contents of Register A. (Display)

Format: \$ A

Explanation: Returns detailed attributes of Register A in the following format:

A	C8	C7	C6	C5	C4	C3	C2	C1	<C/R>
C1:	Frame number display					1 = ON; 0 = OFF			
C2:	Chapter number display					1 = ON; 0 = OFF			
C3:	User Area display					1 = ON; 0 = OFF			

C4 to C8 are set to "0".

Execution: 7 R A <C/R> R <C/R>
 \$ A <C/R> A 0 0 0 0 0 1 1 1 <C/R>
 * Frame number, chapter number and User's Display are enabled.

49) REGISTER B REQUEST LD/CD

Function: Returns the contents of Register B. (Squelch Control)

Format: \$ B

Explanation: Returns Register B video and audio squelch attributes in the following format:

B	C8	C7	C6	C5	C4	C3	C2	C1	<C/R>
C8:	Video squelch disabled;					1 = ON; 0 = OFF			
C7:	Audio squelch disabled					1 = ON; 0 = OFF			

C1 to C6 are set to "0".

Execution: 1 2 8 R B <C/R> R <C/R>
 \$ B <C/R> B 1 0 0 0 0 0 0 0 <C/R>
 * Video squelch is disabled; Audio squelch is enabled.

1 9 2 R B <C/R> R <C/R>
 \$ B <C/R> B 1 1 0 0 0 0 0 0 <C/R>
 * Video and audio squelch are both disabled.

0 R B <C/R> R <C/R>
 \$ B <C/R> B 0 0 0 0 0 0 0 0 <C/R>
 * Video and audio squelch are both enabled

50) REGISTER C REQUEST LD/CD

Function: Returns the contents of Register C. (Miscellaneous)

Format: \$ C

Explanation: Returns function switch setting data in the following format:

C	C8	C7	C6	C5	C4	C3	C2	C1 <C/R>
C1:	Side Repeat				1: ON		0: OFF	
C2:	Load Start				1: ON		0: OFF	
C3:	Power-On Start				1: ON		0: OFF	
C4:	Not Used							
C5:	Back Color Select				1: Black		0: Blue;	
C6:	TxD Terminator				1: CR+LF		0: CR	
C7:	BAUD Rate				1:1200		0: 4800	
C8:	Test Mode				1: ON		0: OFF	

Execution: * R C = 0

16R C <C/R> R <C/R>

* Background color set to Black

\$ C <C/R> C 0 0 0 1 0 0 0 0 <C/R>

* Indicates that background color has been set to Black.

* R C = 16

1 R C <C/R> R <C/R>

* Side Repeat ON, background color set to Blue.

\$ C <C/R> C 0 0 0 0 0 0 0 1 <C/R>

* Indicates Side Repeat is ON, background color set to Blue.

4.7.7 Input/Output Device Control Commands

51) INPUT UNIT REQUEST LD/CD

Function: Reports input data from the remote control unit.

Format: # I

Explanation: The RCU input data is always returned as two ASCII-HEX codes. After several buttons are pressed, the latest digit will be returned.

Once the data has been read out and no buttons are pressed, "No Key" (FF) is returned until the next remote control input is made.

Execution: * No RCU button previously pressed
I <C/R> FF <C/R>
* Key Input 23517
I <C/R> 07 <C/R>
* The last digit is returned, in this case, "7".

52) INPUT NUMBER WAIT LD/CD

Function: Awaits digit input data from remote control.

Format: ? N

Explanation: When this command is entered, the player returns the first digit that is entered through the remote control (0 -9). Only one digit is returned and any other character or non-digit button is ignored.

Execution: * RCU
? N <C/R>
* Digit 1 Input 1 <C/R>

Note: To regain control of the player if no button is pressed, use the CLEAR command.

Level III Commands for CLD-V2600/2400

	Command	Mnemonic	Page	LD	CD
Player Control Commands					
1	Door Open	OP	4-11	✓	✓
2	Door Close	CO	4-11	✓	✓
3	Reject	RJ	4-12	✓	✓
4	Start	SA	4-12	✓	✓
5	Play	(Address) PL	4-13	✓	✓
6	Pause	PA	4-14	✓	✓
7	Still	ST	4-14	CAV	
8	Step Forward	SF	4-15	CAV	
9	Step Reverse	SR	4-15	CAV	
10	Scan Forward	NF	4-15	✓	✓
11	Scan Reverse	NR	4-15	✓	✓
12	Multi Speed Forward	(Address) MF	4-16	CAV	
13	Multi Speed Reverse	(Address) MR	4-16	CAV	
14	Speed	Integer SP	4-17	CAV	
15	Search	Address SE	4-18	✓	✓
16	Stop Marker	Address SM	4-20	✓	✓
17	Frame Set	FR	4-21	✓	
18	Chapter Set	CH	4-21	✓	
19	Time Set	TM	4-22	CLV	✓
20	Track Set	TR	4-22		✓
21	Index Set	IX	4-23		✓
22	Block Set	BK	4-23		✓
23	Clear	CL	4-24	✓	✓
24	Lead Out Symbol	LO	4-24	✓	✓
Control Switch Commands					
25	Audio Control	Integer AD	4-25	✓	✓
26	Video Control	Integer VD	4-25	✓	✓
27	Key Lock	Integer KL	4-27	✓	✓

Level III Commands for CLD-V2600/2400 (cont.)

	Command	Mnemonic	Page	LD	CD
Display Control Commands					
28	Display Control	Integer DS	4-28	✓	✓
29	Clear Screen	CS	4-29	✓	✓
30	Print Character	Integer PR	4-30	✓	✓
Request Control Commands					
31	Frame Number Request	?F	4-31	✓	
32	Chapter Number Request	?C	4-31	✓	
33	Time Request	?T	4-32	CLV	✓
34	Track Number Request	?R	4-32		✓
35	Index Number Request	?I	4-33		✓
36	Block Number Request	?B	4-33		✓
37	P-Block Number Request	?A	4-33		✓
38	TOC Information Request	?Q	4-34		✓
39	Player Active Mode Request	?P	4-35	✓	✓
40	Disc Status Request (LD)	?D	4-36	✓	
41	Disc Status Request (CD)	?K	4-36		✓
42	LVP Model Name Request	?X	4-37	✓	✓
Communication Control Commands					
43	Communication Control	Integer CM	4-38	✓	✓
44	CCR Mode Request	?M	4-38	✓	✓
Register Control Commands					
45	Register A Set (Display)	Integer RA	4-39	✓	✓
46	Register B Set (Squelch Control)	Integer RB	4-42	✓	✓
47	Register C Set (Miscellaneous)	Integer RC	4-43	✓	✓
Register Request Commands					
48	Register A Request (Display)	\$A	4-44	✓	✓
49	Register B Request (Squelch Control)	\$B	4-44	✓	✓
50	Register C Request (Miscellaneous)	\$C	4-45	✓	✓
Input/Output Device Control Commands					
51	Input Unit Request	#I	4-46	✓	✓
52	Input Number Wait	?N	4-46	✓	✓

Level III Commands for CLD-V2600/2400 — LD

	Command	Mnemonic	Page	LD
Player Control Commands				
1	Door Open	OP	4-11	✓
2	Door Close	CO	4-11	✓
3	Reject	RJ	4-12	✓
4	Start	SA	4-12	✓
5	Play	(Address) PL	4-13	✓
6	Pause	PA	4-14	✓
7	Still	ST	4-14	CAV
8	Step Forward	SF	4-15	CAV
9	Step Reverse	SR	4-15	CAV
10	Scan Forward	NF	4-15	✓
11	Scan Reverse	NR	4-15	✓
12	Multi Speed Forward	(Address) MF	4-16	CAV
13	Multi Speed Reverse	(Address) MR	4-16	CAV
14	Speed	Integer SP	4-17	CAV
15	Search	Address SE	4-18	✓
16	Stop Marker	Address SM	4-20	✓
17	Frame Set	FR	4-21	✓
18	Chapter Set	CH	4-21	✓
19	Time Set	TM	4-22	CLV
23	Clear	CL	4-24	✓
24	Lead Out Symbol	LO	4-24	✓
Control Switch Commands				
25	Audio Control	Integer AD	4-25	✓
26	Video Control	Integer VD	4-25	✓
27	Key Lock	Integer KL	4-27	✓

Level III Commands for CLD-V2600/2400 — LD (cont.)

	Command	Mnemonic	Page	LD
Display Control Commands				
28	Display Control	Integer DS	4-28	✓
29	Clear Screen	CS	4-29	✓
30	Print Character	Integer PR	4-30	✓
Request Control Commands				
31	Frame Number Request	?F	4-31	✓
32	Chapter Number Request	?C	4-31	✓
33	Time Request	?T	4-32	CLV
39	Player Active Mode Request	?P	4-35	✓
40	Disc Status Request (LD)	?D	4-36	✓
42	LVP Model Name Request	?X	4-37	✓
Communication Control Commands				
43	Communication Control	Integer CM	4-38	✓
44	CCR Mode Request	?M	4-38	✓
Register Control Commands				
45	Register A Set (Display)	Integer RA	4-39	✓
46	Register B Set (Squelch Control)	Integer RB	4-42	✓
47	Register C Set (Miscellaneous)	Integer RC	4-43	✓
Register Request Commands				
48	Register A Request (Display)	\$A	4-44	✓
49	Register B Request (Squelch Control)	\$B	4-44	✓
50	Register C Request (Miscellaneous)	\$C	4-45	✓
Input/Output Device Control Commands				
51	Input Unit Request	#I	4-46	✓
52	Input Number Wait	?N	4-46	✓

Level III Commands for CLD-V2600/2400 — CD

	Command	Mnemonic	Page	CD
Player Control Commands				
1	Door Open	OP	4-11	✓
2	Door Close	CO	4-11	✓
3	Reject	RJ	4-12	✓
4	Start	SA	4-12	✓
5	Play	(Address) PL	4-13	✓
6	Pause	PA	4-14	✓
10	Scan Forward	NF	4-15	✓
11	Scan Reverse	NR	4-15	✓
15	Search	Address SE	4-18	✓
16	Stop Marker	Address SM	4-20	✓
19	Time Set	TM	4-22	✓
20	Track Set	TR	4-22	✓
21	Index Set	IX	4-23	✓
22	Block Set	BK	4-23	✓
23	Clear	CL	4-24	✓
24	Lead Out Symbol	LO	4-24	✓
Control Switch Commands				
25	Audio Control	Integer AD	4-25	✓
26	Video Control	Integer VD	4-25	✓
27	Key Lock	Integer KL	4-27	✓
Display Control Commands				
28	Display Control	Integer DS	4-28	✓
29	Clear Screen	CS	4-29	✓
30	Print Character	Integer PR	4-30	✓

Level III Commands for CLD-V2600/2400 — CD (cont.)

	Command	Mnemonic	Page	CD
Request Control Commands				
33	Time Request	?T	4-32	✓
34	Track Number Request	?R	4-32	✓
35	Index Number Request	?I	4-33	✓
36	Block Number Request	?B	4-33	✓
37	P-Block Number Request	?A	4-33	✓
38	TOC Information Request	?Q	4-34	✓
39	Player Active Mode Request	?P	4-35	✓
41	Disc Status Request (CD)	?K	4-36	✓
42	LVP Model Name Request	?X	4-37	✓
Communication Control Commands				
43	Communication Control	Integer CM	4-38	✓
44	CCR Mode Request	?M	4-38	✓
Register Control Commands				
45	Register A Set (Display)	Integer RA	4-39	✓
46	Register B Set (Squelch Control)	Integer RB	4-42	✓
47	Register C Set (Miscellaneous)	Integer RC	4-43	✓
Register Request Commands				
48	Register A Request (Display)	\$A	4-44	✓
49	Register B Request (Squelch Control)	\$B	4-44	✓
50	Register C Request (Miscellaneous)	\$C	4-45	✓
Input/Output Device Control Commands				
51	Input Unit Request	#I	4-46	✓
52	Input Number Wait	?N	4-46	✓

CLD-V2600/2400 Remote Control Unit

CU-V113 & RU-V103

CU-V113 & RU-V103 Remote Control:

LEVEL I CONTROL

REJECT: Ceases playback and spins-down the disc.

PAUSE: Ceases playback and displays a squelch screen. Press any motion button to resume.

PLAY: Begins playing a disc, or resumes play.

REPEAT MODE: This button can be pressed to set side repeat; or chapter or track repeat, or auto-return.

STILL / STEP (FWD / REVERSE): Press either of these buttons to produce a still video image (CAV Only). Additional presses of the STEP FWD button moves the image forward one frame at a time. STEP REV moves the image in reverse one frame at a time.

DISP: Displays or removes the display of current chapter/frame/track or time numbers on the screen. During CD playback, track and index numbers are displayed with the elapsed time or track numbers with the disc's absolute time location are displayed.

SCAN (FWD / REVERSE): Press either of these buttons to move quickly forward or backward through the program material on a disc. Rapid scanning continues as long as the button is depressed.

AUDIO: Press this button to select audio output: Digital Stereo, Digital 1/L, Digital 2/R, Audio OFF, Analog Stereo, Analog 1/L, Analog 2/R, Audio OFF.
Note: CDs output digital audio only.

SPEED (DOWN / UP): Press these buttons to set the speed at which multi-speed play will occur. (CAV only.)

CLEAR: Press this button to CLEAR erroneous inputs or to stop a Search operation.

MULTI-SPEED (REV / FWD): Press this button to initiate Multi-Speed Play forward or reverse in the speed that has been set with the SPEED button. (CAV only.)

NUMERIC BUTTONS (0-9): Use these buttons to enter search points on a disc. Use the CHAP/FRAME TRACK/TIME button to set an "address flag", indicating chapter, frame or time number (LD) or track or time number (CD). Then enter the numeric digits for the location and press Search or Play. Digits 1-9 can also be used for viewer responses during Level III program execution. See Level III Command Input Number Wait (?N).

SEARCH: First set the "address flag" using the CHAP/FRAME TRACK/TIME button. Then specify the number

See **Section 3.2.2**, beginning on page 3-4 and continued on page 3-6, for details about the use of each specific remote control button.

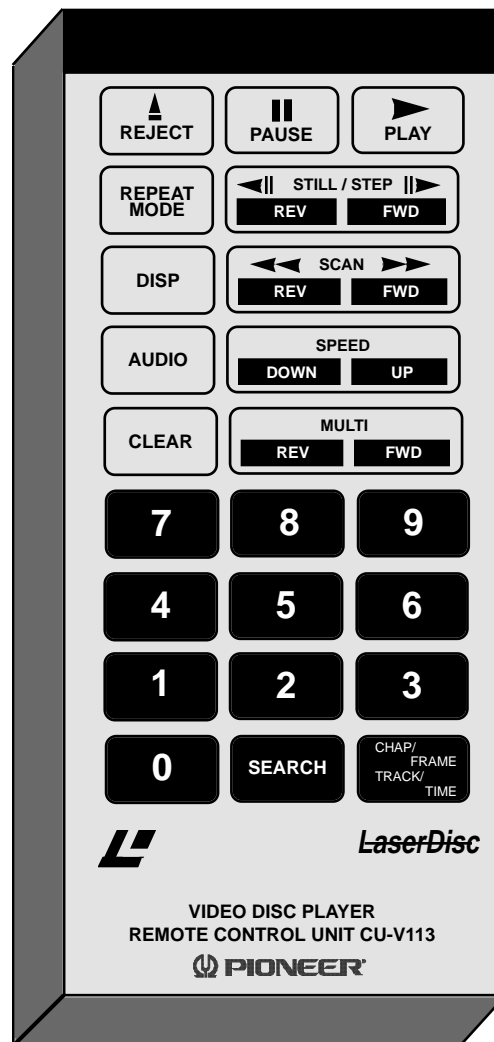

The CU-V113 & RU-V103 Remote Control

to be searched to by using the digit buttons. Press the SEARCH button to execute. After searching, the player presents a still frame on CAV discs or immediately plays on CLV discs or CDs.

CHAP / FRAME TRACK / TIME: Press this button to set the address flag, indicating how a search will be performed, either by chapter or frame number (CAV), chapter or time number (CLV), track or time number (CD).

Note: The CU-V113 / RU-V103 remote control units are not packaged with a cable for connection to the Barcode Terminal on the front of the player. A stereo or mono mini-plug cable can be purchased separately, however, and used to provide the wired connection.

Interface Cable Specifications

Connecting the CLD-V2600/2400 to IBM & Compatible Computers

The CLD-V2600/2400 use these cables to attach to the computers listed below:

Computer	Pioneer Cable #	Connections
IBM PC/XT & Compatibles	CC - 12	DB-15 male to DB-25 female
IBM PS/2 & Commodore Amiga	CC - 12	DB-15 male to DB-25 female
IBM AT & Compatibles	CC - 13	DB-15 male to DB-9 female
IBM Info Window	CK - 15P	DB-15 male to DB-25 male

Pin Configurations for Specific Cables

CC-12	DB-15 male to DB-25 female	CC-13	DB-15 male to DB-9 female																																																
	<table border="0"> <tr> <td>LD Player</td> <td></td> <td>Computer</td> </tr> <tr> <td>GND 1</td> <td>————</td> <td>7 GND</td> </tr> <tr> <td>TxD 2</td> <td>————</td> <td>3 RxD</td> </tr> <tr> <td>RxD 3</td> <td>————</td> <td>2 TxD</td> </tr> <tr> <td>DTR 4</td> <td>————</td> <td>5 CTS</td> </tr> <tr> <td></td> <td></td> <td>6 DSR</td> </tr> <tr> <td>Conn. Housing</td> <td>————</td> <td>Conn. Housing</td> </tr> <tr> <td></td> <td>Shield</td> <td></td> </tr> </table>	LD Player		Computer	GND 1	————	7 GND	TxD 2	————	3 RxD	RxD 3	————	2 TxD	DTR 4	————	5 CTS			6 DSR	Conn. Housing	————	Conn. Housing		Shield			<table border="0"> <tr> <td>LD Player</td> <td></td> <td>Computer</td> </tr> <tr> <td>GND 1</td> <td>————</td> <td>5 GND</td> </tr> <tr> <td>TxD 2</td> <td>————</td> <td>2 RxD</td> </tr> <tr> <td>RxD 3</td> <td>————</td> <td>3 TxD</td> </tr> <tr> <td>DTR 4</td> <td>————</td> <td>8 CTS</td> </tr> <tr> <td></td> <td></td> <td>1 Carrier Detect</td> </tr> <tr> <td></td> <td></td> <td>4 DTR</td> </tr> <tr> <td></td> <td></td> <td>6 DSR</td> </tr> </table>	LD Player		Computer	GND 1	————	5 GND	TxD 2	————	2 RxD	RxD 3	————	3 TxD	DTR 4	————	8 CTS			1 Carrier Detect			4 DTR			6 DSR
LD Player		Computer																																																	
GND 1	————	7 GND																																																	
TxD 2	————	3 RxD																																																	
RxD 3	————	2 TxD																																																	
DTR 4	————	5 CTS																																																	
		6 DSR																																																	
Conn. Housing	————	Conn. Housing																																																	
	Shield																																																		
LD Player		Computer																																																	
GND 1	————	5 GND																																																	
TxD 2	————	2 RxD																																																	
RxD 3	————	3 TxD																																																	
DTR 4	————	8 CTS																																																	
		1 Carrier Detect																																																	
		4 DTR																																																	
		6 DSR																																																	
			Jumper pins 1, 4, & 6 together on DB-9																																																

The CC-12 is an RS-232C cable which interfaces Pioneer's CLD-V2600, CLD-V2600, CLD-V2400, LD-V4400, LD-V8000, LD-V4200 (discontinued), LD-V2200 videodisc players and the LC-V330 AutoChanger to Commodore Amigas and any IBM PC or compatible computer that supports a DB-25 female connector.

The CC-13 is an RS-232C cable which interfaces Pioneer's CLD-V2600, CLD-V2400, LD-V4400, LD-V8000, LD-V4200 (discontinued), LD-V2200 videodisc players and the LC-V330 AutoChanger to IBM PC/ATs or compatibles that support a 9-pin female D-Sub Connector.

CK-15P Kit DB-15 male to DB-25 male

LD Player		Computer
GND 1	————	7 GND
TxD 2	————	3 RxD
RxD 3	————	2 TxD
DTR 4	————	5 CTS
		6 DSR
Conn. Housing	————	Conn. Housing
	Shield	

with two WRAP PLUGS

Male 25-PIN D-Sub Connector	Female 15-PIN D-Sub Connector
Internal Jumper List	Internal Jumper List
2 ————— 3	2 ————— 3
4 ————— 5	4 ————— 5
6 ————— 20	6 ————— 20

This kit contains the CC-03 cable, an RS-232C cable designed to interface Pioneer's CLD-V2600, CLD-2400, LD-V4400, LD-V8000, LD-V4200 (discontinued), LD-V2200 videodisc players to the IBM InfoWindow. However, the CC-03 can also be used to interface the above videodisc players to Pioneer's UC-V102 Videodisc Controller and, with a 25-pin female-to-female adapter, to an IBM PC or compatible that supports a 25-pin RS-232C port. Two wrap plugs, used to test the RS-232C cable in the InfoWindow configuration, are included.

BASIC Sample Program to Test Interface Connections on IBM / Compatible Computers:

```
10 OPEN "COM1: 4800,N,8,1,CS1,DS0,CD0" AS#1
20 INPUT C$: PRINT #1, C$
30 INPUT #1, S$: Print S$
40 GOTO 20
```

(If the adapter is set to #2, the device name is COM2. **PC-DOS access:** If LDP. SYS is registered in CONFIG. SYS, access can be made as LDP. If both adapters #1 and #2 of the serial interface are connected, #2 has priority.

Interface Cable Specifications

Connecting the CLD-V2600/2400 to Macintosh and Apple II Computers

The CLD-V2400 uses the following cables to attach to the computers listed below:

Computer	Pioneer Cable #	Connection
Macintosh Plus, SE, II & Apple IIGS	CC - 04	DB-15 male to Mini-Din 8 male
Apple II, II+, IIE with Super Serial Card	CC - 03	DB-15 male to DB-25 male

Pin Configurations for Specific Cables

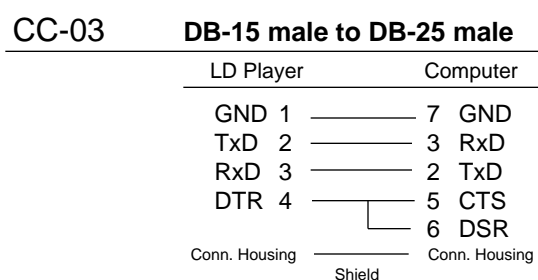

The CC-03 is an RS-232C cable which interfaces Pioneer's CLD-V2600, CLD-V2400, LD-V4400, LD-V8000, LD-V4200 (discontinued), LD-V2200 videodisc players and the LC-V330 AutoChanger to the IBM InfoWindow*, the Apple II series Super Serial Card and to Pioneer's UC-V102 Videodisc Controller. **Note:** With a 25 pin female-to-female adapter, the CC-03 can be used to connect the players to an IBM PC or compatible that supports a 25 pin RS-232C port.

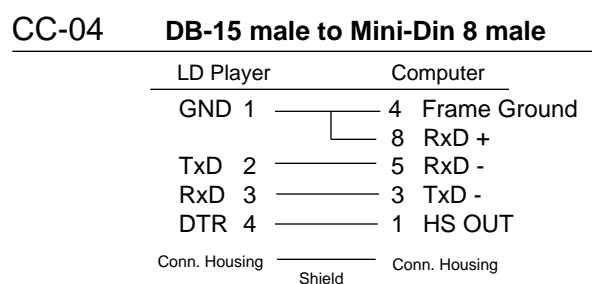



The CC-04 is an RS-232C cable which interfaces Pioneer's CLD-V2600, CLD-V2400, LD-V4400, LD-V8000, LD-V4200 (discontinued), LD-V2200 videodisc players and the LC-V330 AutoChanger to the Macintosh Plus, SE, Macintosh IIs, and Apple II GS computers. It connects the 15-pin RS-232C port on the player to the Circular-8 Modem port on the Apple/Macintosh.

*IBM InfoWindow does not support the LC-V330 AutoChanger.

LaserBarcode™ Standard Commands & Logo

LaserBarcode Standard Command Set

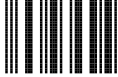
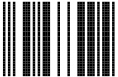
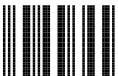
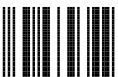
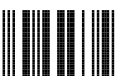
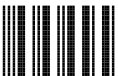
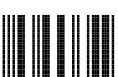
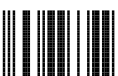
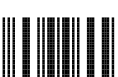
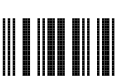
Independent Commands

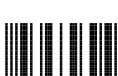
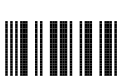
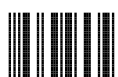
Play		Plays the videodisc inserted in drawer.
Audio Off		Turns Audio OFF.
Audio 1/Left		Sets the audio control attribute to "analog channel 1," plays back analog left channel audio only.
Audio 2/Right		Sets the audio control attribute to "analog channel 2," plays back analog right channel audio only.
Audio Stereo		Sets the audio control attribute to "analog stereo," plays back analog left and right analog channels simultaneously.
Video Off		Turns Video OFF.
Video On		Turns Video ON.
Pause		Pauses the player, presents a squelch screen.
Step Forward (CAV Only)		Steps forward one frame at a time.
Step Reverse (CAV Only)		Steps backward one frame at a time.
Reject/Spin Down		Spins down the player, presents a squelch screen.
Marker Clear		Clears, and plays through Chapter markers.
Debug On		Instructs player to maintain various player settings so barcodes can be tested.
Debug Off		Turns debug feature OFF.

Search Commands

Frame Search (CAV only)



Search to Frame 1000

Chapter Search (CAV & CLV)

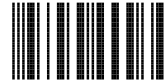

Search to Chapter 2

Segment Play Commands

Frame Segment Play (CAV only)

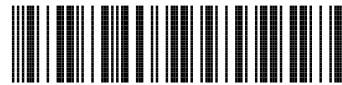

Play from Frame 1000 to Frame 1200

Chapter Segment Play (CAV & CLV)

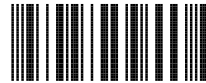

Play from Chapter 2 to Chapter 5

All of the sample LaserBarcodes included on page 1 & 2 of Appendix D were prepared using Pioneer's Bar'n'Coder for the Macintosh®.

The symbol below indicates that an application bearing it supports the standard LaserBarcode command set as established by the LaserBarcode Association. This symbol may be used *only* on applications that adhere to the original LaserBarcode standard command set. Customers look for this logo to assure the application can be used with any player that is LaserBarcode compatible.

Standard LaserBarcodes may be created using Pioneer's Barcode preparation software: The **Bar'n'Coder** for the Macintosh, **Barkoder for Windows** or **LaserBarcode Tool Kit** for IBM PC and MS DOS compatible computers.

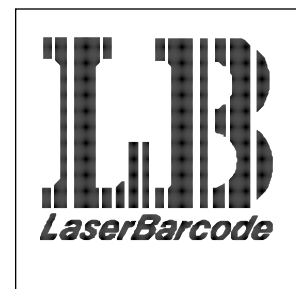







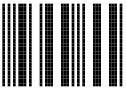
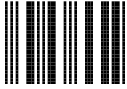
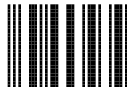
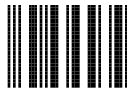
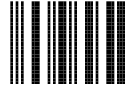

Contact Pioneer New Media Technologies, Inc., Marketing Division at 310-952-2111 for information about licensing the LaserBarcode Logo.

*LaserBarcode™ is a trademark of Pioneer Electronic Corp.
Macintosh® is a registered trademark of Apple Corp.*

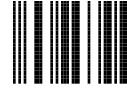
LaserBarcode 2™ Commands & Logo

As described in Section 3.3.3 of this manual, the LaserBarcode Standard was officially revised by the LaserBarcode Association on August 1, 1992, to create the new LaserBarcode 2 (LB2) standard command set. **LB2 contains all of the barcode functions available with the original LaserBarcode standard command set as well as new barcode functions that provide for Time Searches and Time Segment plays on CLV discs, slow motion playback on CAV discs, and access to digital audio.**

Samples of the original LaserBarcode commands are on page D-1 of this Appendix. Samples of the "Extended Commands" included in the LB2 command set are provided below:

LaserBarcode 2 Extended Command Set Sample Barcodes		
<i>Extended Independent Commands</i>		
Start		Instructs the player to spin up the disc from a park position and pause at frame 1 (CAV discs) or at time number 0:00:00 (CLV discs) with video squelched.
Digital Audio Stereo		Sets the audio control attribute to "digital stereo," plays back left and right digital audio channels simultaneously.
Digital Audio Ch 1/L		Sets the audio control attribute to "digital channel 1," plays back digital left channel only.
Digital Audio Ch 2/R		Sets the audio control attribute to "digital channel 2," plays back digital right channel only.
Slow Forward 1 (CAV)		Slow Forward 1 - Instructs the player to play forward at 1/4 the normal speed.
Slow Forward 2 (CAV)		Slow Forward 2 - Instructs the player to play forward at 1/8 the normal speed.
Slow Forward 3 (CAV)		Slow Forward 3 - Instructs the player to play forward, displaying 1 frame / second.
Slow Forward 4 (CAV)		Slow Forward 4 - Instructs the player to play forward direction, 1 frame / 3 seconds.
Slow Reverse 1 (CAV)		Slow Reverse 1 - Instructs the player to play in reverse at 1/4 the normal speed.
Slow Reverse 2 (CAV)		Slow Reverse 2 - Instructs the player to play in reverse at 1/8 the normal speed.
Slow Reverse 3 (CAV)		Slow Reverse 3 - Instructs the player to play in a reverse direction, 1 frame / second.
Slow Reverse 4 (CAV)		Slow Reverse 4 - Instructs the player to play in reverse, 1 frame / 3 seconds.

(Continued on next page)

LaserBarcode 2™ Commands & Logo (cont.)

(Continued from previous page)

LaserBarcode 2 Extended Command Set Sample Barcodes	
Extended Search Command	
Time Search (CLV)	2 Search Time 0:34:56
Extended Segment Play Commands	
Time Segment Play (CLV)	2 Search 0:23:45, Play To 0:34:56
Special Effects Segment (CAV) Frame segment play at Speed 1,2,3, or 4 — in forward or reverse.	2 Search 4000, Fwd. To 5000, Speed 2

All of the LB2 Extended LaserBarcode Commands on pages 3 and 4 were created using Pioneer's Bar'n'Coder 3.0 software for the Macintosh.

Please see the pages 5 - 8 of this appendix for a narrative description of commands available in LB2: "original" LaserBarcode commands and "extended" LB2 commands.

The symbol at right indicates that an application bearing it supports the LaserBarcode 2 command set as established by the LaserBarcode Association. This symbol may be used only on applications that adhere to the LaserBarcode 2 command set. Customers look for this logo to assure the application can be used with any player that is LaserBarcode 2 compatible. (See Player Compatibility Chart, **Appendix F**.)



LaserBarcode 2 barcodes may be created using Pioneer's Barcode preparation software: The **Bar'n'Coder** for the Macintosh, **BarKode for Windows** or **LaserBarcode Tool Kit 2.0** for IBM PC and MS DOS compatible computers.

Contact Pioneer New Media Technologies, Inc., Marketing Division at 310-952-2111 for information about licensing the LaserBarcode 2 Logo.

Each LaserBarcode command is listed below with a description of how the player responds when the code is scanned and transmitted to the player. Remember, all LB2 commands are supported only by players that carry the LB2 logo. Players that carry the original LaserBarcode logo will play LB2 “Original Commands”, but do not support LB2 “Extended Commands”.

A. Independent LaserBarcode 2 Commands

There are 26 independent LB2 commands: Fourteen “original” independent LaserBarcode commands and 12 “extended” independent LaserBarcode commands.

Original Independent Commands (LB & LB2)

1. **Video On** - Sets the video control attribute to “on.” Video is turned on during playback.
2. **Video Off** - Sets the video control attribute to “off.” Video is turned off during playback.
3. **A-Stereo** - Sets the audio control attribute to “analog stereo,” plays back left and right analog audio channels simultaneously.
4. **A-Ch 1/Left** - Sets the audio control attribute to “analog channel 1,” plays back analog left channel only.
5. **A-Ch 1/Right** - Sets the audio control attribute to “analog channel 2,” plays back analog right channel only.
6. **Audio Off** - Sets the audio control attribute to “off,” mutes both analog and digital audio playback.
7. **Play** - Instructs the player to play the disc:
 - a) If player is in *Park Mode*, the Play command instructs the player to spin up and begin playing the disc.
 - b) If player is in *Still* or *Pause Mode*, the Play command instructs the player to resume playback of the disc from that point.
8. **Pause** - Instructs the player to halt playback of the disc and squelches the video. Pause can be used with both CAV and CLV discs.
9. **Step Forward** - Instructs the player to step 1 frame in the forward direction. Step Forward can only be used with CAV discs.*
10. **Step Reverse** - Instructs the player to step 1 frame in the reverse direction. Step Reverse can only be used with CAV discs.*
11. **Park Disc** - Instructs the player to stop playback, spin down the disc and put the player in *Park Mode*.
12. **Clear** - Instructs the player to clear a stop marker during motion sequences. For example, if a scanned barcode instructs the player to search to frame 1000 and play to frame 3000, sending the Clear command will clear the frame 3000 stop marker and playback will continue beyond that point on the disc.

(Continued on next page)

* Step Forward and Step Reverse can also be used with CLV discs, if they are played on an LD-V8000 player.

LaserBarcode 2™ Commands & Logo (cont.)

Original Independent Commands (LB & LB2)

(Continued from previous page)

The final two original independent LaserBarcode commands are designed for use in barcode development and testing. The Debug On and Debug Off commands allow the barcode developer to test printed barcodes to determine their accuracy. They are described below.

13. **Debug On** - Instructs the player to maintain various player settings so that barcodes can be tested. For example: If the Display is turned on by the user through the remote control unit or front panel button, scanning Debug On will instruct the player to maintain that setting for subsequent barcode commands. Normally, when barcodes are transmitted to the player, the Display is turned off. Debug On will also instruct the player to maintain previously set video and audio attributes. So, if the player is set to stereo with the video on, these attributes will be maintained even if the barcode you scan changes the attributes to a different setting. Again, this is done so the developer can test the accuracy of the general operation of the barcode.
14. **Debug Off** - Instructs the player to disable the Debug On mode and allows exact execution of the barcode as defined. Debug Off need only be used if Debug On has been previously set.

Extended Independent Commands (LB2)

15. **Start** - Instructs the player to spin up the disc from a park position and pause at frame 1 (CAV discs) or time number 0:00:00 (CLV discs) with video squelched.
16. **D-Stereo** - Sets the audio control attribute to "digital stereo," plays back left and right digital audio channels simultaneously.
17. **D-Ch 1/Left** - Sets the audio control attribute to "digital channel 1," plays back digital left channel only.
18. **D-Ch 1/Right** - Sets the audio control attribute to "digital channel 2," plays back digital right channel only.

NOTE: Many discs do not have digital audio. Digital audio playback can only be implemented if digital audio is encoded on the disc. Please refer to the documentation for the particular videodisc in use.

The Slow Forward and Slow Reverse commands below can only be used with CAV discs.

19. **Slow Forward 1** - Instructs the player to play forward at 1/4 the normal speed.
20. **Slow Forward 2** - Instructs the player to play forward at 1/8 the normal speed.
21. **Slow Forward 3** - Instructs the player to play forward, displaying 1 frame / second.
22. **Slow Forward 4** - Instructs the player to play forward at 1 frame / 3 seconds.
23. **Slow Reverse 1** - Instructs the player to play in reverse at 1/4 the normal speed.
24. **Slow Reverse 2** - Instructs the player to play in reverse at 1/8 the normal speed.
25. **Slow Reverse 3** - Instructs the player to play in reverse, displaying 1 frame / second.
26. **Slow Reverse 4** - Instructs the player to play in reverse at 1 frame / 3 seconds.

B. LaserBarcode 2 Search Commands

The are three LaserBarcode 2 Search Commands: Two original search commands and one extended search command.

Original Search Commands

1. **Frame Search** - Instructs the player to search to the specified frame and enter *Still Mode*. This command can only be used with CAV discs.
2. **Chapter Search** - Instructs the player to:
 - a) search to the specified chapter and enter *Still Mode* on CAV discs.
 - b) search to the specified chapter and enter *Pause Mode* on CLV discs.†

This command was modified to include CLV chapter search under LB2.

Extended Search Command (for CLV discs)

3. **Time Search** - Instructs the player to search to the specified time number and enter *Pause Mode*.† This command can only be used with CLV discs.

C. LaserBarcode 2 Segment Play Commands

The are four LaserBarcode 2 Segment Play commands: Two “original” LaserBarcode Segment Play commands and two “extended” LB2 Segment Play commands.

Original Segment Play Commands

1. **Frame Segment** - Instructs the player to search to the start frame number and play to the end frame number. When the motion segment is completed, the player enters *Still Mode*. This command can only be used with CAV discs.
2. **Chapter Segment** - Instructs the player to search to the start chapter number and play to the end chapter number. When the motion segment is completed, the player will:
 - a) enter *Still Mode* on the fist frame of the next chapter on CAV discs.
 - b) enter *Pause Mode* on the first frame of the next chapter on CLV discs.†

Extended Segment Play Commands

3. **Time Segment** - Instructs the player to search to the start time number and play to the end time number. When the motion segment is completed, the player enters *Pause Mode*.† This command can only be used with CLV discs.
4. **Special Effects Segment** - Instructs the player to search to the start frame number and play to the end frame number in the slow motion forward or reverse directions. This command can be used with CAV discs only. Specify speed and direction:

Direction	Speed
Forward or Reverse	Slow Motion 1 = 1/4 x normal Slow Motion 2 = 1/8 x normal Slow Motion 3 = 1 frame / second Slow Motion 4 = 1 frame / 3 seconds

†On an LD-V8000 player this command will end in *Still Mode*.

Note: The LB2 standard defines a range for each slow motion setting. The playback speeds described in the previous sections relate to the performance of Pioneer players only. Playback may vary depending on the manufacturer of a particular player. The LB2 format allows the following range of speeds: Slow Forward or Reverse 1 = 1/4 to 1/3 speed; Slow Forward or Reverse 2 = 1/12 to 1/8 normal speed; Slow Forward or Reverse 3 = 1 frame per second; Slow Forward or Reverse 4 = 1 frame every 2 or 3 seconds.

Barcode CD Command Set Sample Barcodes

Play Track - Instructs the player to search to the beginning of a specified track and play to the end of that track. (Track 01-99)



Play Track 02

Play From Track - Instructs the player to search to the beginning of a specified track and play to the end of the disc. (Track 01-99)

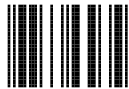

Play From Track 06

Play Index - Instructs the player to search to the beginning of a specified index within a specified track and play to the beginning of the next index. (Track 01-99, Index 01-99)

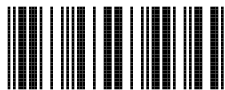

Play Index 0401

Play Time Segment - Instructs the player to search to the first specified time number and play to the second specified time number. CD Time numbers consist of a five digit argument: a two digit number for minutes (00-99), a two digit number for seconds (00-59) and a single digit number for block (0-7).

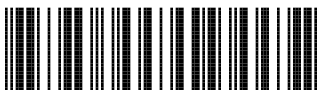

Search 03244, Play To 05122

All of the sample Barcode CD commands above were prepared using Pioneer's Bar'n'Coder for the Macintosh®.

Barcode CD™ Commands & Logo (cont.)

Barcode CD barcodes may be created using Pioneer's Barcode preparation software: The **Bar'n'Coder** for the Macintosh, **Barkoder for Windows** or **LaserBarcode Tool Kit** for IBM PC and MS DOS compatible computers.

Barcoded materials for CDs bearing the Barcode CD logo below use the standard command set described on the first page of this appendix. These barcodes will play on any LD/CD combination player that is CD barcode compatible, such as the Pioneer CLD-V2600 and the CLD-V2400.

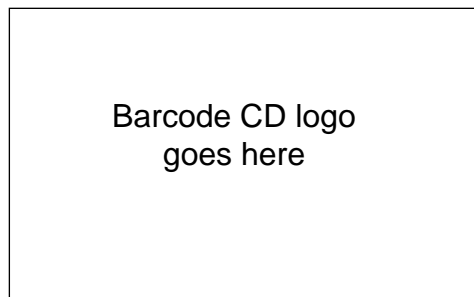

For more information, contact Pioneer New Media Technologies, Inc., Engineering Support, East Coast — 201-327-6400; West Coast — 310-952-2111.

*Barcode CD™ is a trademark of SONY Corp.
Macintosh® is a registered trademark of Apple Corp.*

Barcode Formats & Pioneer Player Compatibility

Pioneer Industrial Videodisc Players, the CLD-V2600, CLD-V2400, LD-V4400, LD-V8000, LD-V2200, LD-V2000, LD-V4300D, the LD-V4200 with LaserBarcode Adapter/15, the LD-V6000A/ LD-V6010A with LaserBarcode Adapter/25, the LC-V330 (AutoChanger), are fully LaserBarcode compatible, accepting original LaserBarcode Standard Commands.

Pioneer CLD-V2600, CLD-V2400, LD-V4400 and LD-V8000 are LaserBarcode 2 compatible. LB2 includes all of the original LaserBarcode Standard Commands and LB2 extended commands that allow for Time Searches and Time Segment Play on CLV discs, slow motion playback on CAV discs and digital audio access.

The CLD-V2600 & CLD-V2400 also accept Barcode-CD standard barcodes for control of Compact Audio discs. See **Player Compatibility with Barcode Standards** below.

Player Compatibility with Barcode Standards								
Standard	LD-V2000	LD-V2200	CLD-V2600 CLD-V2400	LD-V4400	LD-V8000	LC-V330	LD-V4200	LD-V6000 <i>Discontinued Models</i>
LaserBarcode	Yes (UC-V104BC Only)	Yes	Yes	Yes	Yes*	Yes (With LBA 15)	Yes With LBA 15	Yes With LBA 25
LaserBarcode2	No	No	Yes	Yes	Yes**	No	No	No
Barcode CD	No	No	Yes	No	No	No	No	No

* LD-V8000 players with serial numbers greater than KJ3906076 (after December '91) have built-in LaserBarcode capability. All others require LBA 15.

**LD-V8000 players with serial numbers greater than KJ3912276 (after August 1992) have built-in LaserBarcode 2 capability. LD-V8000 players manufactured before August 1992 can be updated to LB2 by contacting Pioneer Electronics Service and ordering an EPROM Replacement Kit.

NOTE: Pioneer Barcode Readers, UC-V108BC and UC-V109BC, as well as the discontinued Pioneer UC-V104BC scan original LB commands, LB2 extended commands, and Barcode CD commands and can be used to send barcode commands to the above listed players.

- See **Appendix D** for sample LaserBarcode Standard Commands and sample LaserBarcode 2 Extended Commands.
- See **Appendix E** for sample Barcode CD commands.
- See **Appendix G** for information about Pioneer Barcode Readers, the UC-V108BC and the UC-V109BC.

Using Pioneer Barcode Readers

The Pioneer Barcode Reader UC-V108BC

Overview of the UC-V108BC

Pioneer Autoscanning Barcode Reader UC-V108BC scans LaserBarcode™, LaserBarcode 2™ and Barcode CD™ commands and sends them to control Pioneer's barcode compatible LaserDisc or combination LaserDisc/Compact Disc players. It may be used with the Pioneer LD-V8000, LD-V4400, CLD-V2600, CLD-V2400, LD-V2200, LC-V330 Auto Changer with LBA/15, the discontinued LD-V4200 with LBA/15 and with the discontinued LD-V6000A with LBA/25. *The UC-V108BC does not work with the LD-V2000 player. See **Appendix F**, page F-1, for player barcode-compatibility.*

The Autoscanning Barcode Reader provides a new scanning concept — there is no need to draw the scanner across the barcode. In addition, the Autoscanning reader adds the most frequently used functions of a remote control. (See **Figures A & B** below.)

Four views of the UC-V108BC

Illustration not included

Figure A

- | | | |
|--------------------------|-------------------------------|--|
| 1 — Reset Switch | 6 — SEND/REPEAT Button | 11 — AUDIO Button† |
| 2 — Battery Cover | 7 — PLAY Button | 12 — DISPLAY Button |
| 3 — Infrared Transmitter | 8 — SCAN FWD / REV Buttons | 13 — PAUSE |
| 4 — Sensor Unit | 9 — STEP FWD / REV Buttons* | 14 — Control Cable Connection Terminal |
| 5 — READ Button | 10 — SKIP FWD / REV Buttons** | |

* STEP FWD /REV are generally used only with CAV discs. With the LD-V8000 player, however, these functions can be used with CAV and CLV discs.

** The SKIP FWD / REV function cannot be used with the LD-V8000.

† Use the AUDIO Button to toggle through eight Audio options: 1) Digital Stereo, 2) Digital 1/L, 3) Digital 2/R, 4) Audio Off, 5) Analog Stereo, 6) Analog 1/L, 7) Analog 2/R and 8) Audio Off. All eight selections are available with discs that are encoded with both digital and analog sound. The first four selections are available with discs encoded only with digital sound and selections 5 through 8 are available with discs encoded only with analog sound.

Battery Installation / Transmitting Infrared Signals

Illustration not included

Figure B

Scanning Barcodes with the UC-V108BC Autoscanning Reader

Place the Autoscanning reader sensor over the barcode. Line up the arrow on the scanner with the left edge of the barcode. Press the blue READ button and the barcode is automatically scanned. A “Beep” indicates the code has been successfully scanned. Before transmitting the command, place a disc in the player and spin it up by pressing the PLAY button on the reader, the PLAY button on the front of the player, or by scanning and sending a “START” or “PLAY” barcode command to the player.

Sending Barcode Commands to the Player with the UC-V108BC

Once a disc has been spun-up, barcode commands scanned with the UC-V108BC reader can be transmitted to the player automatically in wired mode, or they can be sent in infrared mode by pointing the infrared sensor on the front of the unit toward the remote sensor on the player and pressing the SEND/REPEAT button.

When using the reader in infrared mode, make sure the control cable is disconnected from both the player and the reader and that the batteries are fresh. The reader can transmit the infrared signal approximately 23 feet with new batteries installed. The path of transmission should be unobstructed and within a 30 degree angle of the remote sensor. The Autoscanning reader holds the last barcode scanned in its memory; this barcode command can be re-sent by pressing the SEND/REPEAT button again. A “Beep” indicates the code has been successfully transmitted.

A control cable is packaged with the unit to provide a wired connection. The control cable has mono mini plugs at both ends. The end that connects to the Autoscanning reader has a locking connector and when inserted into the plug on the reader should be twisted to provided a secure connection. The plug on the other end of the cable is simply connected to the mini-jack on the front of the player. Make sure the player is turned off when connecting or disconnecting the cable.

Built-in Remote Control Functions Available on the UC-V108BC

Remote control functions available at the press of a button include: Play, Pause, Step* Forward and Reverse, Scan Forward and Reverse, Chapter / Track Skip** Forward and Reverse, Audio Select and Display.

Pioneer Barcode Reader UC-V109BC

Overview of the UC-V109BC

Pioneer Barcode Reader UC-V109BC scans LaserBarcode™, LaserBarcode 2™ and Barcode CD™ commands and sends them to control Pioneer’s barcode compatible LaserDisc or combination LaserDisc/Compact Disc players. The UC-V109BC Barcode Reader also has eight remote control function buttons built-in. It works with Pioneer Industrial LaserDisc players LD-V8000, LD-V4400, CLD-V2600, CLD-V2400, LD-V2200, the LC-V330 Auto Changer with LBA/15, the discontinued LD-V4200 with LBA/15, and

* Step Fwd / Rev are used only with CAV discs; With the LD-V8000 player, however, they can be used with CAV and CLV discs.

** The Skip Fwd / Rev function cannot be used with the LD-V8000.

Using Pioneer Barcode Readers (cont.)

the discontinued LD-V6000A with LBA/25. The unit does not work with the LD-V2000 player. See **Appendix F, page F-1** for player barcode-compatibility.

The following remote control functions are available on the UC-V109BC: Play, Pause, Scan Forward and Reverse, Step Forward and Reverse*, Chapter /Track Skip Forward and Reverse**. Press the remote control function buttons on the side of the reader and point the infrared transmitter at either end of the reader toward the player to send commands in infrared mode. (See **Figure C** below.) If the reader is connected to the player via wire, the commands are sent automatically regardless of the orientation of the infrared transmitter.

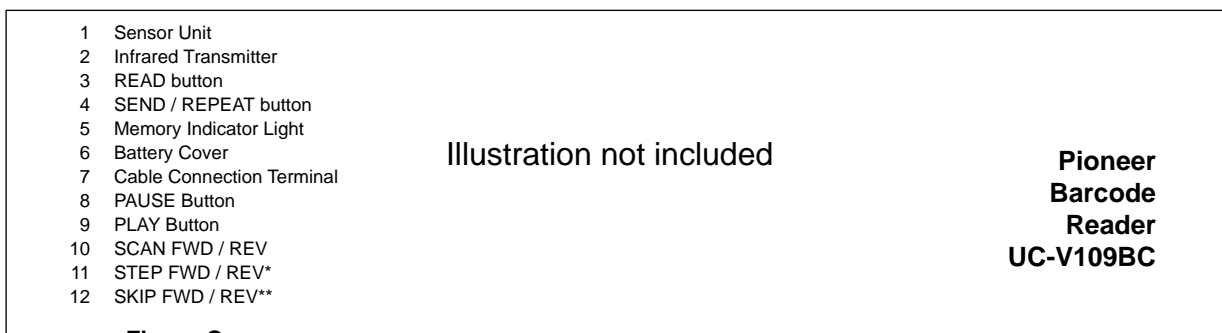

Figure C

Preparing the UC-V109BC Barcode Reader for Use

- Check to make sure that the batteries are fresh and placed correctly in the battery compartment of the reader.
- If you will be using the reader in wired mode, make sure that the wired connections to the reader and the player are secure.

Using the UC-V109BC Barcode Reader

Turn on the barcode compatible LaserDisc player or combination LD/CD player, insert a LaserDisc or Compact Disc that has accompanying barcode materials. Spin-up the disc by pressing the PLAY button on the reader, or on the front of the unit, or by sending a START barcode command on LB2 compatible players. Grasp the reader like a pen and place the sensor next to the barcode, tilted at about a 30 degree angle from a vertical position. Press the blue READ button. Start scanning in the white space beside the barcode and move the sensor tip of the reader horizontally across the barcode at a constant speed. You will hear a “beep” and the red indicator light on the top surface of the reader will light up when the code has been successfully read. This light remains lit as long as the barcode command is held in memory (about 60 seconds). **NOTE:** The barcode may be scanned from left to right or from right to left. (See Scanning Tips, **Figure D** on the next page.)

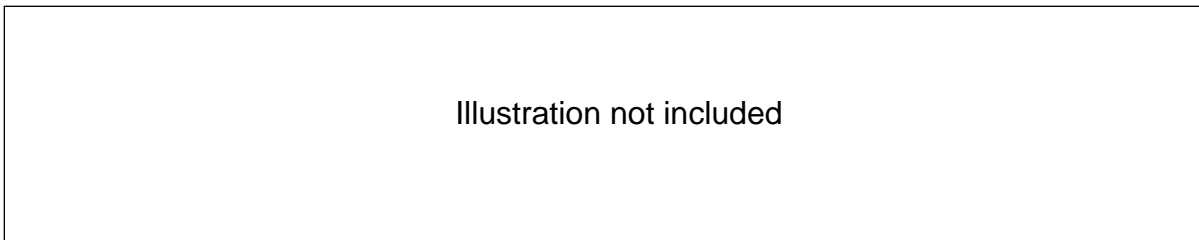

Figure D Scanning a LaserBarcode

Wireless Operation of the UC-V109BC

The UC-V109BC reader works in both wired and infrared mode. When using the reader in infrared mode, press the red SEND/REPEAT button and point either the tip or the blunt end of the reader toward the infrared sensor on the player to transmit the code. Also, make sure the wire is disconnected from both the reader and the player or commands will not be successfully sent to the player.

The UC-V109BC can send an infrared signal about 23 feet to the player with fresh batteries installed. It may take up to two seconds to send a barcode command from the reader to the player. The infrared sensor must receive the entire transmission to process the command correctly. Make sure the reader's infrared transmitter remains pointed at the infrared sensor on the player and that the signal path is unobstructed for the entire transmission of the command. A "beep" signals that the player has received the command.

Wired Operation of the UC-V109BC

When the reader is attached to the player via wired connection, the code is transmitted automatically to the player as soon as it is scanned. There is no need to press the SEND/REPEAT button. A beep will sound as the barcode is read.

NOTE: In both wired or infrared mode, the reader holds the last barcode scanned in its memory for approximately 60 seconds. The last barcode scanned can be re-sent by pressing the SEND/REPEAT button again. Each time the SEND/REPEAT button is pressed, the code is retained an additional 60 seconds.

NOTE: *Pioneer Industrial Videodisc Players LD-V8000, LD-V4400, CLD-V2600, CLD-V2400, LD-V2200, LD-V2000, LD-V4300D, the discontinued LD-V4200 with LaserBarcode Adapter/15, the discontinued LD-V6000A/LD-V6010A with LaserBarcode Adapter/25, and the LC-V330 (AutoChanger), are fully LaserBarcode compatible, accepting all LaserBarcode Standard Commands. The LD-V8000, LD-V4400, CLD-V2600, CLD-V2400 are LB2 Compatible. The LaserBarcode 2 command set contains all of the "original" LB commands and 15 "extended" commands. (See **Appendix D** for more information on LaserBarcode 2.)*

CLD-V2600 & CLD-V2400 Internal Player Controls

CLD-V2600 & CLD-V2400 Control Blocks

The following control blocks are used within the CLD-V2600 & CLD-V2400.

- 1.) Communication control block
- 2.) Player control block

1) Communication control block

The communication control block is divided into eleven units. It analyzes commands sent via various input methods, and executes the commands.

Front Panel Buttons

The CLD-V2600 player has POWER ON, OPEN/CLOSE, PLAY, PAUSE, SKIP FORWARD, SKIP REVERSE, DISPLAY buttons and a SCAN FORWARD, SCAN REVERSE shuttle knob on the front panel. **Section 3.1 Front Panel Control Buttons**, page 3-1.

The CLD-V2400 player has POWER-ON, OPEN/CLOSE, PLAY, SKIP FORWARD, SKIP REVERSE, SCAN FORWARD, SCAN REVERSE buttons on the front panel. See **Section 3.1 Front Panel Control Buttons**, page 3-1.

Wireless Remote Control Unit

This is the remote sensor on the front panel. It converts the infrared Barcode or RCU code to an electric signal.

Wired Remote Control Unit

This is the Barcode terminal on the front panel. It receives the Barcode or RCU code via the stereo pin jack.

Head Phone Jack (CLD-V2600 only)

This is the jack for a headphone on the front panel. There is also a volume control.

Key Decoder

When a front panel button (key) is pressed, the key decoder generates data corresponding to the pressed button and sends it to the Key/RCU Command Processor.

RCU Decoder

When an RCU button (key) is pressed, the RCU decoder generates data corresponding to the pressed button and sends it to the Key/RCU Command Processor.

Key/RCU Command Processor

This command processor analyzes the front panel button /RCU command data received from the Key Decoder or the RCU Decoder, for execution.

RS-232C Command Processor

The RS-232C command processor analyzes RS-232C command data received from the RS-232C buffer for execution.

CLD-V2600 & CLD-V2400 Internal Player Controls

RS-232C Buffer Unit

The RS-232C buffer unit receives input from the 15-pin D-SUB connector on the rear panel. The unit consists of an input command data buffer and an output status data buffer.

Character Generator

Both the CLD-V2600 & the CLD-V2400 can generate character signals to be superimposed on the video signals displayed by the players. Character data is sent from command processors to the character generator.

Status display LED

The CLD-V2400 player has four LED status display indicators on the front pane. The CLD-V2600 has a display window that provides status information. See **Section 2.1 Player Indicators** for details.

LED Driver

The LED driver turns on the LED indicators.

2) Player control block

The player control block analyzes player control commands received from the command processor of the communication control block and executes them to control the player accordingly.

Servo Control Unit

This unit communicates with the digital servo unit and controls player processing.

Video Control Unit

This unit analyzes video control commands received from the communication control block to control output video signals.

Audio Control Unit

This unit analyzes audio control commands received from the communication control block to control output audio signals.

Focus Servo Unit*

This unit controls the focus servo mechanism.

Tracking Servo Unit

This unit controls the tracking servo mechanism.

Slider Servo Unit

This unit controls the slider servo mechanism.

Spindle Servo Unit

This unit controls the spindle servo mechanism.

(See Player Control Block diagram on next page.)

* A servo unit constantly takes readings for focus, tracking, spindle operations, etc, and provides information to the player so it can make appropriate adjustments.

CLD-V2600 & CLD-V2400 Internal Player Controls

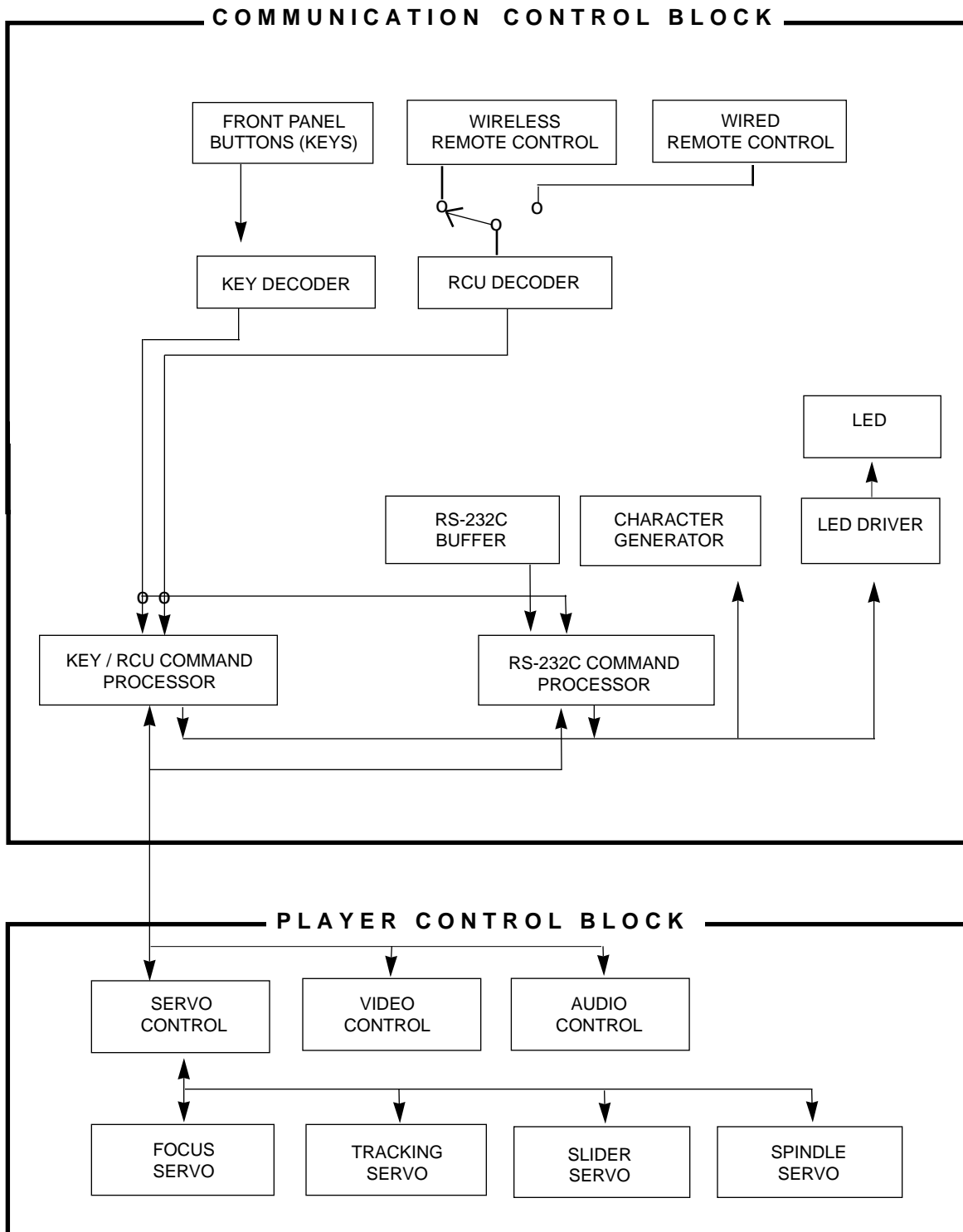

CLD-V2600 & CLD-V2400 Internal Player Controls

Independent Command Processor

The CLD-V2600 and the CLD-V2400 players can be controlled by several different methods: From the Front Panel Buttons, the Remote Control Unit or Barcode Reader (Level I) or from an external computer via the RS-232 port (Level III).

An independent command processor inside the player assures the most appropriate operating environment is used. Because of this, the same commands may perform differently, depending on the control method. See **Chapter 3 Manual Control — Section 3.1**, using Front Panel buttons; **Section 3.2**; using a Remote Control Unit, **Section 3.3**, using the Barcode Reader. Refer also to **Appendices B, D, E** and **F**. See **Chapter 4, External Computer Control**, for information about sending commands from an external computer and for command descriptions.

Most of the commands input to the player have arguments such as frame number, chapter number, time number, track number or various parameters. An argument storage area and an address flag indicating the frame, chapter, time, track, index or block number are provided for each control method. Therefore, arguments input for one particular control method do not affect operations performed with another method.

Internal Player Components

Address Specification Flag Register (computer control)

This register indicates whether a particular address argument sent from a computer is a frame, chapter, track, index, time, or block number.

Digit Buffer (computer control)

This buffer stores the numeric values of arguments sent from an external computer. The contents of this buffer are sent to the specified registers for command execution.

Command Processor (computer control)

This processor reads the contents of the RS-232C buffer. It sends the arguments to the digit buffer, or executes commands.

RS-232C Buffer

This is the RS-232C Input/Output data buffer. Twenty-two bytes are used for input and another 22 bytes are used for output.

Address Specification Flag Register (manual control)

This register indicates whether the address arguments are frame numbers, chapter numbers, time numbers or track numbers for normal control operations.

CLD-V2600 & CLD-V2400 Internal Player Controls

Digit Buffer (manual control)

This buffer stores the numeric values of arguments for normal control operations. The contents of this buffer are sent to the specified register for command execution.

Command Processor (manual control)

This reads the contents of the RCU/key decoder and sends the contents to the digit buffer if they are arguments, or executes the command if the RCU/key decoder contains a command.

RCU/Key Decoder

This monitors RCU/key inputs. If arguments and commands are input, the decoder generates the internal code corresponding to the input data.

Current Frame or Time Register

This register stores the current frame number (LD-CAV) or the current time number (LD-CLV or CD).

P-Time Register

This register stores the P-Time (elapsed time within a track) location on a CD.

Current Chapter or Track Register

This register stores the current chapter number if an LD encoded with chapters is playing. It stores the current track number if a CD is playing.

Current Index Register

This register stores the current index of a specific track on a CD.

Search Frame or Time Register

This register stores the frame number (LD-CAV) or time number (LD-CLV or CD) of the search destination. The search operation is performed by comparing the contents of this Search Frame or Search Time Register and the contents of the Current Frame or Current Time Register.

Search Chapter or Track Register

This register stores the chapter (LD) or track (CD) number of the search destination. The search operation is performed by comparing the contents of this Search Chapter Register or Search Track Register and the contents of the Current Chapter Register or the Current Track Register.

Search Index Register

This register stores the index number of the search when a CD is playing.

CLD-V2600 & CLD-V2400 Internal Player Controls

Mark Frame or Mark Time Register

This register stores a frame (LD-CAV) or time (LD-CLV or CD) number marker. If a marker is set and the address specification flag indicates frame or time, the contents of this register are compared with the current frame or time. If they match, the player automatically holds a still frame or pauses at a specific time location.

Mark Chapter or Mark Track Register

This register stores a chapter (LD) or track (CD) number marker. If a marker is set and the address specification flag indicates chapter or track, the contents of this register are compared with the current chapter or track. If they match, the player automatically pauses at the chapter or track.

Mark Index Register

This register stores an index (CD) number marker. If a marker is set and the address specification flag indicates index, the contents of this register are compared with the current index. If they match, the player automatically pauses at the index.

Speed Register

This register stores the speed used for multi-speed play.

Audio/Video Control Register

This register controls audio/video output.

Display Control Register

This register controls the display of frame numbers/time numbers, chapter numbers, track numbers and specific user-generated characters.

Display Buffer

This buffer holds character data. It provides up to 20 characters on 3 lines for the system and up to 20 characters on 10 lines for the user.

REG. A to REG. C

These are switches used for the specific CLD-V2600 or CLD-V2400 functions. The settings Load Start, Power-On Start and Baud Rate are read into Register C from the Function Switches at power-on.

CLD-V2600/2400 Internal Player Registers

Many commands given to the player are accompanied by such arguments as frame number or chapter number. These values are set in the respective registers of the player. The following figure shows a model of the internal registers of the CLD-V2600 & CLD-V2400. It illustrates the relationship between the registers. This model is helpful in understanding the initial state of a particular register or how a given command changes the contents of a register.

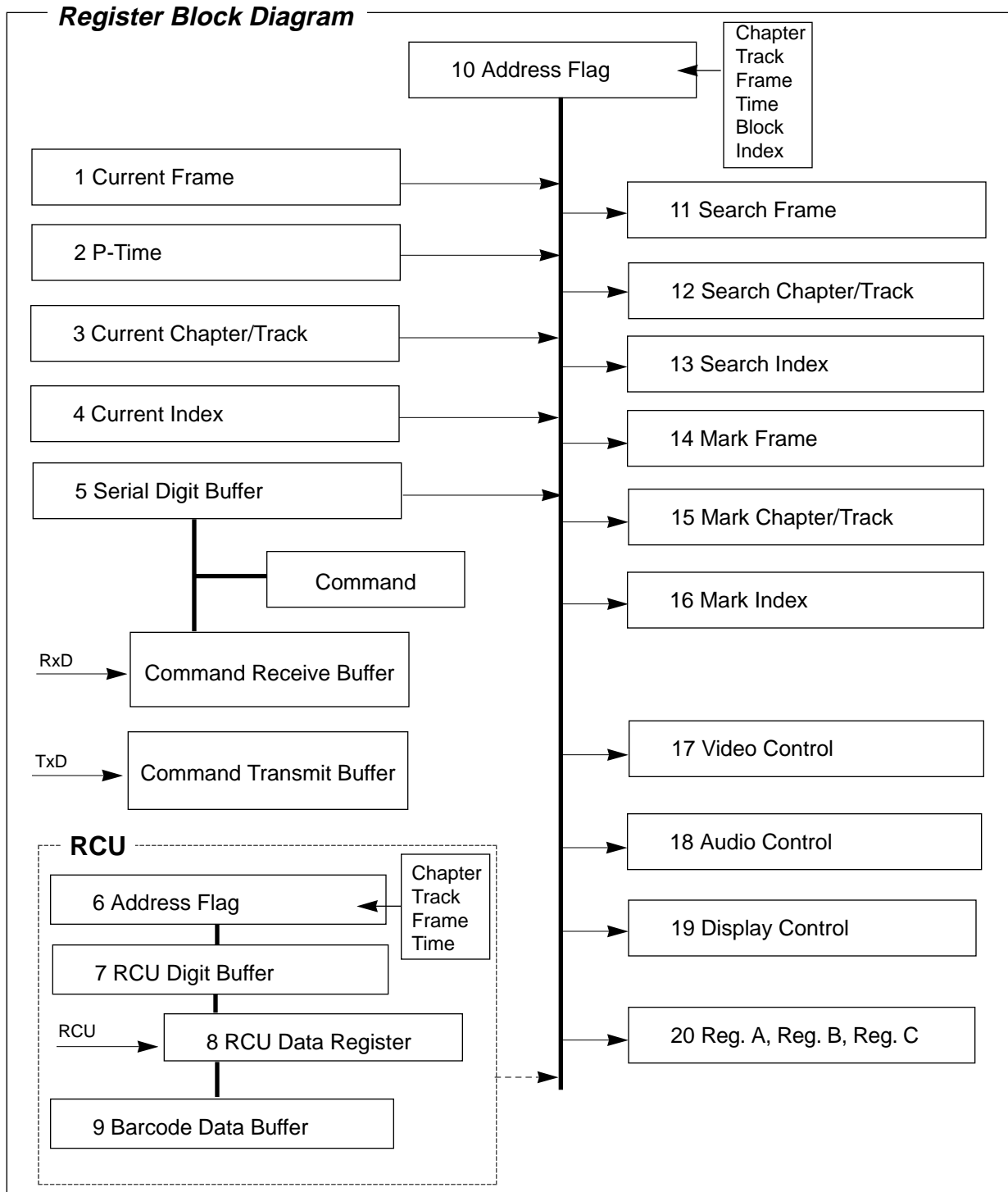

CLD-V2600/2400 Internal Player Registers

The registers have the following functions.

1. Current Frame or Time (including Block number)

Contains the current picture frame number (LD-CAV), or contains the current time number (LD-CLV or CD) or time and block numbers (CD).

2. P-Time

Contains the track internal elapsed time. This is mainly for display purposes.

3. Current Chapter or Track Number

Contains the current chapter number (LD) or track number (CD).

4. Current Index

Contains the current index number.

5. Serial Digit Buffer

The command line argument values are contained here while the commands are placed in a separate exclusive register. When the command evaluation is made, the contents of this buffer are transferred to a specified register.

6. Remote Control-Use Address Flag

When the remote control unit is used to perform a Search, this flag specifies whether the address is assigned as a chapter, track, frame or time.

7. Remote Control Digit Buffer

Contains the numbers input by remote control.

8. Remote Control Data Register

Temporarily contains the data input by remote control.

9. LaserBarcode Buffer

Transmits LaserBarcode compatible data from among the data input by remote control.

10. Serial-Use Address Flag

Under serial command, this flag specifies whether the address is assigned as a chapter, track, frame, time, block or index.

CLD-V2600/2400 Internal Player Registers

11. Search Frame or Time (including Block)

Contains the frame number (LD-CAV), time (LD-CLV, CD) or time including block number (CD) to be searched. The search operation is performed while comparing the contents of the Search Frame or Time Register and Current Frame or Time Register.

12. Search Chapter or Track

Contains the chapter number (LD) or track number (CD) to be searched. Its use is the same as that of the Search Frame or Time Register.

13. Search Index

Contains the index number searched. Its use is the same as that of the Search Frame or Time Register.

14. Mark Frame or Time (including Block)

Contains the frame number (LD-CAV), time (LD-CLV, CD) or time including block number (CD) for the marker which is used to indicate the end point of auto play. When auto play is engaged the contents of the Mark Frame or Time Register and the Current Frame or Time Register are compared.

15. Mark Chapter or Track

Contains the chapter (LD) or track number (CD) for the marker. Its use is the same as that of the Mark Frame or Time Register.

16. Mark Index

Contains the index number for the marker. Its use is the same as that of the Mark Frame or Time Register.

17. Video Control

The video ON/OFF switch.

18. Audio Control

The audio selection switch.

19. Display Control

The frame number and chapter character display ON/OFF switch.

20. Register A, Register B, Register C

These switches are concerned with the special functions of the CLD-V2600 or the CLD-V2400.

CLD-V2600/2400 Notes

- 1)** The model name of the CLD-V2600 is P1527XX
The model number of the CLD-V2400 is P1518XX.
- 2)** If a picture stop code is recorded on currently playing CAV LaserDisc, the player enters *Still Mode* at the stop code point. If a picture stop is encountered during a stop marker or auto stop segment play, an error message is returned.
- 3)** If a frame specified by an auto stop or by a stop marker is missing, the player enters the *Still Mode* just beyond the specified frame.
- 4)** When the CLD-V2600 or CLD-V2400 is controlled by a computer, command execution may sometimes be suspended if front panel buttons or remote control buttons are pressed. To prevent this, use the Key Lock (KL) command to lock out front panel and remote control input.
- 5)** CLV frame mode (for CLV discs encoded with seconds) is not available on the CLD-V2600 or CLD-V2400 by remote control. CLV frame numbers can, however, be searched to under computer control and then verified by issuing the ?F command. The player lands in Pause at the specified CLV frame number. Although CLV frame numbers are not visible on-screen by issuing the Display (DS) command, they can be displayed on-screen in *Test Mode*. **NOTE:** Test Mode is generally used by authorized service center personnel for diagnostic and testing purposes when servicing the player.
NOTE: CLV frame numbers can be accessed on the Pioneer LD-V4400 and the LD-V8000 by remote control or computer control. On the LD-V4400 under remote control, once the target frame is hit, the player plays immediately; under computer control it lands in pause. On the LD-V8000 under remote control or computer control, the player searches to the CLV frame number and holds a still frame.
- 6)** If the video area of a CDV has been recorded using the PAL system, sound only will be reproduced when it is played on a CLD-V2600 or CLD-V2400. (The disc is treated as a CD.)
- 7)** If a non-existent address is specified via computer control while a CD is playing, an error code (E04) is returned. Users can access the CD's Table of Contents (TOC) by issuing the ?Q command via computer control. The following information is returned: first track, last track, and total playing time (absolute time) of the CD. See **Section 4.7.4 Request Commands, #38 TOC Information** on page 4-34.
- 8)** CDV playback begins from the video area. When the video playback is completed, playback may end or the video may be replayed depending on how the player's *Repeat Mode* is set. When you want to play back audio, search for the track you want to hear. When audio playback is completed, playback may end or the audio may be replayed again, depending on the *Repeat Mode*.
- 9)** During CD and CDV playback, if the stop marker is set to ± 1 block from the start point after a Pause, the player will not hold the stop marker.
- 10)** During LD CLV playback, if the stop marker is set to ± 1 frame, from the start point after a Pause, the player will not hold the stop marker.
- 11)** During CD playback, it is not possible to search for the absolute time address 0 minutes, 0 seconds, 0 block.

CLD-V2600/2400Notes

Laser Vision Player
CLD-V2600/CLD-V2400
User's Manual Version 2.0 December 1993

Pioneer New Media Technologies, Inc.

© 1993 Pioneer New Media Technologies, Inc.
All rights reserved. No part of this publication may be reprinted or reproduced
in any form without the permission in writing of the copyright holder.

Special Features of the CLD-V2600

Please See Chapter 1, Section 1 of this manual for an overview of the features of the CLD-V2400. The CLD-V2600 player has all these features and more. Below is a listing of the special additional features of the CLD-V2600 player. On the following pages are illustrations of the player's front and rear panels.

Please Note: The CLD-V2600 has the same Level III command set as the CLD-V2400 and the commands all function the same as do on the CLD-V2400. The CLD-V2600/2400 command set is described in **Chapter 4** of this manual.

Special features of the Pioneer CLD-V2600 industrial videodisc player:

- Brushless spindle motor for extended operation applications such as kiosks, etc.

On the front panel

- Headphone jack with volume control
- Pause button, Step Forward/Step Reverse & Skip Forward/Skip Reverse buttons, Also, a Display button
- Shuttle dial forward and reverse fast speed control
 - Two speed CAV scan speed, 9x and 32x
 - CLV "clear scan" and "normal" scan
- More descriptive front panel display with frame, time and chapter numbers
- Fully plug compatible with CLD-V2400, same RS-232C mnemonic command set
- 12 line x 20 character user display (2 more lines than 2400)
 - The CLD-V2400 makes available lines 0-9,
 - the CLD-V2600 makes available line 0-11.

On the back panel:

- Built-in RF modulator (not separate accessory)
- S -Video Out
- Function switch control allowing manual selection of blue or black squelch screen
- Function switch diagram on rear panel.



EAST

Sales Office
& Engineering Support
600 East Crescent Avenue
Upper Saddle River, NJ 07458-1827

TEL: (201) 327-6400
FAX: (201) 327-9379

CENTRAL

Sales Office
1263 Hamilton Parkway
Itasca, IL 60143

TEL: (708) 285-4500
FAX: (708) 285-4570

WEST

Corporate Headquarters, Sales
& Engineering Support
2265 E. 220th St.,
Long Beach, CA 90810

TEL: (310) 952-2111
FAX: (310) 952-2990

PIONEER ELECTRONIC (EUROPE)

N.V. Branch Office
417 Bridport Rd. Greenford, Middlesex, ENGLAND UB6-8UE

PIONEER ELECTRONICS (AUSTRALIA) PTY. LTD.

178-184 Boundary Rd., Braeside, Victoria 3195, AUSTRALIA

PIONEER ELECTRONIC CORPORATION

4-1, Meguro 1-Chome, Meguro-ku, Tokyo 153, JAPAN